

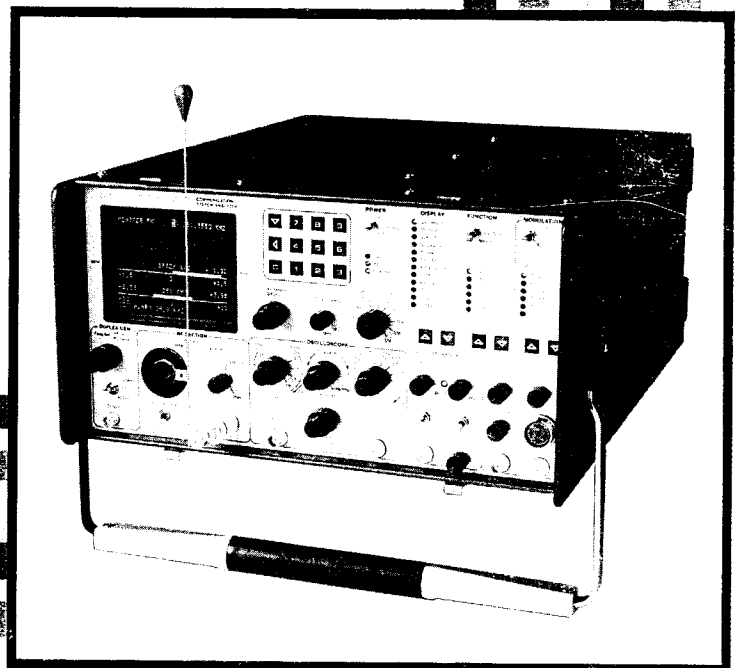

**MOTOROLA INC.**

**test equipment**

**Communications  
System Analyzer  
OPERATOR'S MANUAL**



**R-2008C**

## COMPUTER SOFTWARE COPYRIGHTS

The Motorola products described in this instruction manual may include copyrighted Motorola computer programs stored in semiconductor memories or other mediums. Laws in the United States and other countries preserve for Motorola certain exclusive rights for copyrighted computer programs, including the exclusive right to copy or reproduce in any form the copyrighted computer program. Accordingly, any copyrighted Motorola computer programs contained in the Motorola products described in this instruction manual may not be copied or reproduced in any manner without the express written permission of Motorola. Furthermore, the purchase of Motorola products shall not be deemed to grant either directly or by implication, estoppel, or otherwise, any license under the copyrights, patents or patent applications of Motorola, except for the normal non-exclusive, royalty free license to use that arises by operation of law in the sale of a product.

EPS-34440-A

## MOTOROLA TEST EQUIPMENT PRODUCTS LIMITED WARRANTY (EXCLUDES EXPORT SHIPMENTS)

Motorola Test Equipment Products (herein the "product") that are manufactured or distributed by Motorola Communications Group Parts Department are warranted by Motorola for a period of one (1) year from date of shipment against defects in material and workmanship.

This express warranty is extended to the original purchaser only. In the event of a defect, malfunction, or failure during the period of warranty, Motorola, at its option, will either repair, or replace the product providing that Motorola receives written notice specifying the nature of the defect during the period of warranty, and the defective product is returned to Motorola at 1313 East Algonquin Road, Schaumburg, IL 60196 transportation prepaid. Proof of purchase and evidence of date of shipment (packing list or invoice) must accompany the return of the defective product. Transportation charges for the return of the product to Purchaser shall be prepaid by Motorola.

This warranty is void, as determined in the reasonable judgement of Motorola, if:

- (a) The product has not been operated in accordance with the procedures described in the operating instruction;
- (b) The seals on non-user serviceable components or modules are broken;
- (c) The product has been subject to misuse, abuse, damage, accident, negligence, repair or alteration.

In no event shall Motorola be liable for any special, incidental, or consequential damages.

In the event Motorola elects to repair a defective product by replacing a module or subassembly, Motorola, at its option, may replace such defective module or subassembly with a new or reconditioned replacement module or subassembly. Only the unexpired warranty of the warranty product will remain in force on the replacement module or subassembly. EXCEPT AS SPECIFICALLY SET FORTH HEREIN. ALL WARRANTIES EXPRESS OR IMPLIED, INCLUDING ANY IMPLIED WARRANTY OF FITNESS FOR A PARTICULAR PURPOSE OR MERCHANTABILITY, ARE EXCLUDED.

EPS-30828-O

Specifications subject to change without notice.

™, Motorola, Private-Line, and Digital Private-Line are trademarks of Motorola, Inc.

■ Printed in U.S.A. ■ © 1983 Motorola, Inc.

Use R-2001E  
Manual For Calibration

 **MOTOROLA**  
Communications  
Sector

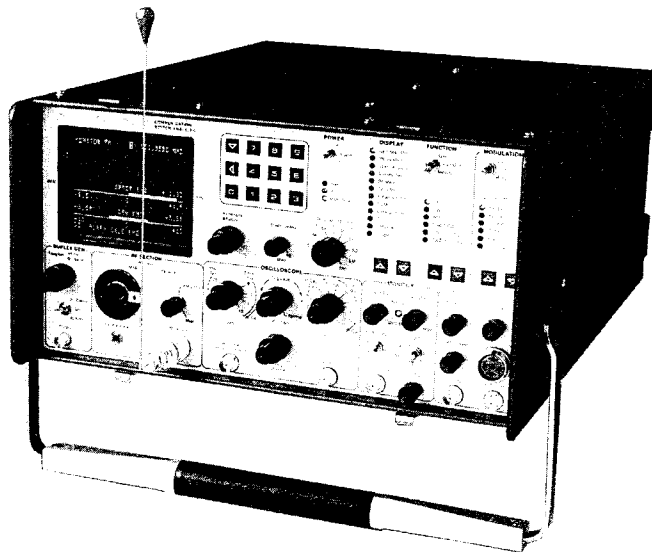

## R-2008C

© Motorola, Inc. 1983  
All Rights Reserved  
Printed in U.S.A.



**Motorola Test  
Equipment Products**

1313 E. Algonquin Rd.  
Schaumburg, IL 60196

68P81069A70-0  
6/28/84-MG



## R2008C OPERATORS MANUAL

TABLE OF CONTENTS	PAGE
1.0 INTRODUCTION	1
A. Cellular test capability in the R2001C	
B. Retain full R2001C capability	
C. Both signaling and RF test capability	
D. Automatic test sequence for FCC parameter verification	
E. Manual control interface for transceiver troubleshooting	
F. Hardcopy output option for record keeping and customer assurance	
G. R2001C capabilities	
2.0 THE CELLULAR CONCEPT	7
A. <u>How cellular works</u>	
3.0 TESTING CELLULAR MOBILES	10
A. Unique signaling requirement	
B. Processor controlled transceiver	
C. 666 channels	
D. SAT frequency checking	
E. Power level control	
F. Channel handoff	
G. NAM installation checking	
H. Manual control of the transceiver	
4.0 R2008C TEST CAPABILITIES	12
A. Built-in signaling modem	
B. Single channel operation	
C. Cell initiated, mobile initiated, automatic, and manual test sequences	
D. SAT tone verification	
E. Signaling data verification	
F. Test progression indicator	
G. Frequency error, output power, and peak modulation measurements	
H. Error detection and readout	
4.1 Setup instructions	14
A. Signalling sequence mode	
B. Manual mode	
4.2 Operating Instructions	16
A. Front panel control settings	
B. Setting up the duplex frequency	
C. Selecting the cellular test mode	

1.	INITIAL PARAMETER ENTRY	17
	a. System identification (SID)	
	b. Mobile identification number (MIN)	
	c. Forward control channel (FOCC)	
	i. Channel increment	
	ii. Printer option	
2.	CELL INITIATED TEST SEQUENCE	18
	a. Call processing steps	
	b. Channel handoff	
	c. Power level tests	
	d. Modulation level tests	
3.	MOBILE INITIATED TEST SEQUENCE	22
	a. Call processing steps	
	b. Channel handoff	
	c. Power level tests	
	d. Modulation level tests	
	e. Dialed telephone number	
4.	MANUAL TEST	24
	a. Command Entry	
	b. Command List	
	i Input and output descriptions	
	c. Examples of use	
5.	AUTOMATIC TEST SEQUENCE	27
	a. Test Initialization	
	b. Test Output	
	c. Printer operation	

#### 5.0 APPLICATION NOTES

A.	Receiver audio level testing	30
B.	Transmitter deviation	32
C.	Receiver sensitivity	33
D.	Duplex sensitivity	34
E.	Power level setting	36
F.	SAT phase	37
G.	RSSI level testing	40
H.	Testing Signalling at Threshold Level	42

#### APPENDICES

A.	Cell Initiated Test Step Definition	43
B.	Mobile Initiated Test Step Definition	46
C.	Detailed Cell Initiated Test Actions	48
D.	Detailed Mobile Initiated Test Actions	51

E. Warning and Error Messages	54
F. Manual Test Commands	58
G. Epson RX-80 Printer Setup	64





## 1.0 INTRODUCTION

The R2008C is an expansion of the R2001C which extends its testing capability to include the unique requirements of cellular radio systems. Any existing R2001C communications system analyzer can be modified to an R2008C. With the modification, all of the capability of the R2001C is retained with the cellular test sequences being added as an extension of the tone memory display.

Cellular test capability in the R2008C includes performance verification for both the digital signaling and the RF transceiver aspects of the cellular radio. In the cellular test mode, the analyzer simulates the basic aspects of the central cell site. It provides all of the signaling required to allow both call origination and call reception testing on the cellular transceiver. In addition, once the voice path is established, the R2008C can then be used to simulate cell site to cell site handoffs, to control the transmitter power level, and to execute performance tests normally associated with a transceiver.

A fully automatic test sequence is provided which sequences through an operator selectable number of the 666 cellular channels and measures the transmitter output power, frequency error, and modulation limiting for each channel. An RS232 printer output (1200 baud) is available in the Auto Test mode to create a test result printout which could be used for record keeping and customer assurance.

To complete the package, the R2008C also provides the interface to manually control the transceivers that are compatible with the Advanced Mobile Phone Service Cellular Mobile Telephone Equipment Specification, May 1983. This separate interface bypasses the normal RF signaling interface and allows direct control over transceiver functions such as channel selection, transmitter key, transmitter audio, and receiver audio. Also available through this interface is access to the number assignment module (NAM) and the nonvolatile memory (NVM). A total of 43 commands are available for the purpose of setting up, checking out, and troubleshooting the cellular radio.

## THE R2001C

The R2001C communication system analyzer is a portable test instrument designed for servicing and monitoring of portable, mobile, and land base communications equipment operating over the frequency range of 1 MHz to 1 GHz. The unit performs the functions of signal generation, frequency error and modulation measurement. It is also capable of a variety of tests normally associated with the following devices;

- Spectrum analyzer
- Duplex offset generator
- Modulation oscilloscope
- Frequency counter
- AC/DC digital-analog voltmeter
- RF wattmeter
- General purpose oscilloscope
- Multi-mode code synthesizer
- Distortion/sinad meter
- Sweep generator

Microprocessor. a Motorola M-6800 series microprocessor permits keyboard entry of data, autoranging of displays, fast frequency access, and permanent storage of often-used frequencies and codes. Generate and monitor RF frequencies, tone codes, and timing sequences can be programmed into a nonvolatile memory, saving time and eliminating entry errors. When one particular type of equipment is continuously serviced, the unit can be programmed to select the mode of operation required when first turned on.

Display. All functions, generated or monitored, are presented on an 8 cm x 10 cm cathode ray tube (CRT) in both analog and digital format, with the name of the function being displayed. The CRT also displays control settings eliminating the need for operator search of different equipment panels. Digital readouts are visually aided by the use of the continuously autoranging analog line segments, which are similar to a bar graph. Each has a base line and calibration markers, in addition to the intensified segment showing the measurement. The user selectable displays are listed in a column beneath the display heading on the front panel. Choosing a display is accomplished by pressing an arrow button below the column, for up or down movement, as required. When the appropriate arrow is pressed, the LED adjacent to the selected display illuminates. Function is selected in the same way, providing rapid, accurate changes in service capability at the touch of a button.

System warnings. To aid the technician in servicing, visual warnings will appear on the CRT when certain overload or caution conditions exist. Displays warn of low battery power, overheating of the RF load, or an improper attenuator setting for particular measurements. In addition, a continuous audible alarm sounds when a preset deviation limit is exceeded in

monitor modes. This limit is entered by using the keyboard and may be programmed from 0.1 kHz to 99.9 kHz, with 100 Hz resolution.

Functions. The following paragraphs briefly describe the major functions of the communications system analyzer.

AM, FM, CW, DSB Signal generation. The built-in general purpose signal generator provides continuous coverage of the HF, VHF, UHF and 800MHz land mobile spectrum for receiver testing. Many forms of external and internal modulation can be simultaneously impressed on the carrier signal for actual composite signals. The frequency range of the RF signal generator is from 10 kHz to 1000 MHz in 100 Hz steps. The output of up to 1 volt RMS provides sufficient amplitude to get through misaligned tuners and receivers, and is especially effective when changing a receiver's frequency. The high level, clean output is available over the entire frequency range of the communications system analyzer. The output frequency is referenced to an internal time base which can be calibrated to the WWV standard.

Simultaneous modulation. Modulation is simultaneously available from an internal 1 kHz tone generator, a multi-mode code synthesizer, and from external inputs. The external modulation can be voice from a standard Motorola mobile radio microphone (which plugs into the front panel of the instrument), as well as a signal applied to the external BNC input. Separate controls are provided for independently setting the levels of the 1 kHz tone, the code synthesizer, and the external modulation sources. The 1 kHz test tone is a convenient source of modulation for making sinad (signal to noise and distortion) measurements. A MOD OUT connector provides external access to all of the modulation signals.

Modulation display. The recovered audio waveform, or audio used to modulate the generator carrier can be viewed on the CRT. It is used to graphically measure deviation, and to aid in waveform analysis.

Sweep generation. The sweep generator mode provides an RF output that is swept in frequency across a band centered at the programmed frequency. A synchronized horizontal sweep for the internal oscilloscope allows filter characteristics to be easily determined. This is ideal for in-depth troubleshooting of IF amplifiers and filters.

Distortion/Sinad metering. A comprehensive check of receiver performance can be made with the distortion/Sinad meter. An analog line segment and digital display of distortion and Sinad are automatically displayed on the CRT in the normal generate

display or can be called up in the DVM display. The only hookups required are from the R2001C RF output to the RF input of the receiver under test, and from the receiver audio output to the R2001C sinad input. The measurement and appropriate servicing can then be accomplished without the need for a separate signal generator, sinad meter and distortion analyzer.

Multi-mode code synthesizer. The communications system analyzer generates Private Line tones (PL), Digital Private Line codes (DPL), multi-tone sequential paging codes and tone-remote base signaling tones. All codes are available at the MOD OUT jack, as well as being used internally to modulate the RF signal generator. This eliminates the necessity of using separate generators and oscillators for general servicing, setting transmitter deviation, or for checking tone-remote-base control lines. Time sequences are also stored in the tone memory to provide fast set-up and to eliminate errors. User programmable two-tone timing sequences are also provided to allow the storage of non-standard or future time sequences.

Off-the-air monitor. The 1.5uV sensitivity of the communications system analyzer receiver allows off-the-air-monitoring and measurement of transmitter frequency error and deviation to 1000 MHz. A variable squelch allows weak signals to be monitored, but can be set higher to ensure the proper signal-to-noise ratio for measurement accuracy. The off-the-air monitor function enables frequent parameter checks without leaving the shop, thus spotting system degradation early and keeping service costs down. Bandwidth can be set wide for off-channel signal location or wide band FM; or narrow for maximum sensitivity and selectivity.

IF display. When the IF display mode is selected, the communications system analyzer's receiver IF envelope is shown on the CRT. This allows the technician to qualitatively and quantitatively assess the amplitude modulation envelope of a transmitter.

Spectrum analyzer. In this mode of operation the CRT displays a window of the RF spectrum whose bandwidth (from 1-10 MHz) is determined by the dispersion/sweep control. The center frequency of this window ranges from 4 MHz TO 1,000 MHz, selectable by entering a specific center frequency with the keyboard. This center frequency is digitally displayed at the top of the CRT screen, eliminating the need for an external signal generator, and counter to provide markers. Once a signal is centered on the screen, positive identification is aided by switching the analyzer to monitor AM or FM and listening to the demodulated output via the built-in audio amplifier and speaker. The spectrum analyzer's center frequency can be scanned up or down at rates varying from 0.5 kHz per second to 5 MHz per second, using the RF scan control. Slow rates are used to precisely determine a subject signal's frequency while faster rates are used for locating intermittent transmissions or viewing large areas of the spectrum in a short time. Uses of

the spectrum analyzer are: Intermodulation interference identification, IF and RF signal tracing, transmitter harmonic measurements, transmitter spurious checks, and receiver local oscillator radiation.

RF burnout protection. At RF input levels above 200mW, in any operating mode, the input automatically switches to the internal 125 watt RF load, thus protecting the attenuator and signal generator against damage from a keyed transmitter. If power above 200 mW is applied in any mode except the power monitor mode, an audible alarm sounds and a visual warning on the CRT directs the operator to switch to the power monitor mode.

#### CAUTION

To prevent undue stress on the protection circuits is recommended to always switch the system to the power monitor mode before applying power in excess of 200 mW. Additional protection is also obtained by making it a practice not to leave the step attenuator in the 0 dB position.

Terminated RF power measurement. RF power is automatically measured when the communications system analyzer is in the power-monitor mode. The built-in RF load dissipates up to 50 watts for three minutes and up to 125 watts for one minute. If a high power transmitter should be keyed into the unit for a time long enough to threaten overheating of the power measuring circuitry, the audible alarm sounds and the CRT display changes to read RF load over-temp, thus warning the technician to de-key. This instrument function is further enhanced by the simultaneous indication of RF power output, carrier frequency error, and modulation, all on the same CRT display.

In-line power measurement. Use of the Motorola ST-1200 series wattmeter elements in conjunction with the analyzer's External Wattmeter display provides measurement of forward and reflected antenna power on the CRT display. This capability eliminates the complex hook-ups and the additional instruments normally required for antenna measurements.

Duplex generator. In this mode, the communications system analyzer simultaneously receives and generates the signals for duplex radio servicing, while generated and monitored frequencies are observed on the CRT. In the 0-10 MHz range, the 'freq. set' control tunes the proper offset frequency for the VHF and UHF bands. The 45 MHz mode provides a single offset for the 800 MHz range. A switch is also provided to select high or low side offset, as required. The duplex generator provides enhanced capability to service equipment such as repeaters, car telephones and emergency medical telemetry portables.

500 kHz Oscilloscope. This general purpose scope is ideal for waveform analysis in two-way communication servicing. Use it for viewing modulation signals (either internally or externally gen-

erated), detection of asymmetric modulation or audio distortion, and general purpose signal tracing and troubleshooting.

Frequency counter. The frequency counter measures inputs in a range from 10 Hz to 35 MHz. Its 5 digit auto-ranging output is displayed on the CRT and allows precise measurement and setting of offset oscillators, 12 MHz and 455 kHz IF's, PL frequencies and other external input signals. This function will also operate simultaneously with the generator or monitor receiver modes of operation. Frequency measurement of transmitted carriers and other signals higher than 35 MHz is easily accomplished with the frequency error readout in the monitor modes.

AC/DC Voltmeter. Switching to the DVM mode provides a digital-analog voltage presentation on the CRT, along with the corresponding dBm value. The auto-ranging display provides full scale deflections of 1, 10, 100 and 300 volts. AC or DC measurement is selected on the CRT. The meter's wide dynamic range and three digit display are ideal for setting power supply voltages, checking bias levels, and setting audio levels. Like the frequency counter, the DVM will operate simultaneously with generate or monitor operation.

## 2.0 THE CELLULAR CONCEPT

Conventional VHF mobile telephone systems use a single transmitter site to cover a given service area. A cellular mobile telephone system, on the other hand, divides the service area into smaller coverage areas called cells. A cellular system consists of a continuous pattern of these hexagon-shaped cells, each having a 5 to 10 mile radius. Within each cell is a centralized base station which contains transceivers and related control equipment for the channels assigned to that cell. All of the cells within a system are then connected either by dedicated land lines, microwave links, or a combination of both to a central control site. The central control site, or controller, is responsible for the overall control of the system and the interface to the land line network.

A cellular car phone in the cell system is under the indirect control of the central controller. A series of control channels over which only digital signaling is allowed, and voice channels which allow both audio and signaling, are used for control and data transfer as well as for conversation once the call is established. The control channels are divided into three groups: Forward control, paging, and access channels. The control channel generally provides some basic information about the particular cellular system such as the system identification number and the range of channels to scan to find the paging and access channels. Paging channels are the normal holding place for the idle cellular radio. When a call is received at the central controller for a cellular radio, the paging signaling will occur on a paging channel. In responding to a page or when originating a call, the radio telephone will use an access channel where two way data transfer occurs to determine the initial voice channel. In many systems all three control channel functions will be served by the same channel for a particular cell. The R2008C operates in this single data control channel mode. Only in the very high density areas will multiple channels be required.

Voice channels are primarily used for conversation with signaling being employed as necessary to effect cell to cell handoffs, control cellular radio output power and to control special local features. Data from the cell site, forward data, and data from the mobile, reverse data, is sent at a 10 kbit/sec rate utilizing direct frequency modulation. The data is formatted into groups of words with a distinct binary preamble that allows the receiver to synchronize to the incoming data.

In addition to the digital signaling, there are two tone signaling mechanisms employed in the cell system. The SAT, or Supervisory Audio Tone, is one of three frequencies around 6 kHz. It is generated by the cell site, checked for frequency by the cellular radio, and then transponded back to the cell site on the reverse voice channel. The cellular radio uses the SAT to verify that the signal being received on the FVC is from the appropriate cell. When the central controller signals the

mobile regarding a new voice channel, it also informs the mobile of the SAT frequency to expect on the new FVC. The returned SAT is used at the cell site to verify the presence of the car phone on the designated channel. A separate 10 kHz Signalling Tone, (ST), is utilized by the mobile on the reverse voice channel to acknowledge various commands from the cell site.

When first turned on, the cellular radio-telephone will scan through the nationwide set of forward control channels and measure the signal strength on each one. It will then select the strongest one and receive the overhead control message. From the overhead message, the radio will be able to determine whether or not it is in its home system, and the range of channels to scan for paging and access. Radios not in their home system will be able to use other systems, depending upon the level of service requested by the user and the extent of roamer arrangements the system operators have made. The radio next scans each paging channel in the specified range and tunes to the strongest one. On that channel the radio continuously receives the overhead message information plus paging messages. At this point the radio idles, continuously updating the overhead message information in its memory and monitoring the paging messages for its phone number. When a page match occurs, the radio scans each of the channels designated as access channels and tunes to the strongest one.

On the access channel, the radio acknowledges the page and thus notifies the central controller of its cell location. The controller then assigns a voice channel and a SAT code to the radio. Upon reception of the voice channel command the radio tunes to the voice channel, verifies the presence of the proper SAT frequency and transponds the tone back to the cell site. At the cell site, the reception of the SAT tone signals the central controller that the radio is ready for the call. An alert order is then sent to the radio which responds with a 10 kHz signalling tone. The subscriber unit rings for 65 seconds or until the user answers. Then the 10 kHz signalling tone is terminated to alert the central controller that the user has answered. The central controller then connects the incoming call to the appropriate circuit leading to the cell in contact with the radio.

As the call progresses, the cell site continuously monitors the reverse channel for signal strength. Transmitter power level commands will be sent to the cellular radio as required to maintain the received signal level within prescribed limits. This is done to minimize interference possibilities within the frequency reuse scheme. If the mobile is at its maximum allowed power for the cell that it is within and the received signal at the cell is approaching the minimum allowable, the cell will signal the central controller. The central controller will in turn have a scanning receiver at each of the surrounding cell sites measure the receive signal strength. The site with the strongest signal will be the site to which the call will be handed off. The handoff and transmitter power level changes are



executed by interrupting the conversation with a burst of data containing the command. The radio acknowledges the order by a data burst in the case of a power control order, or by 50 msec 10 kHz signaling tone burst in the case of a handoff. It should be noted that this data exchange happens very quickly and is hardly noticed by the user.

When the call is terminated by the party calling the cellular radio, the central controller issues a release order to the radio which acknowledges with a 10 kHz signaling tone burst and ceases transmission. If the call was terminated by the user of the cellular radio, the signaling tone burst signals the central controller which terminates the connection. In either case after call termination, the cellular radio goes back to rescan the nationwide set of forward control channels and repeats the process it performed at first turn on to re-establish itself on a paging channel.

When the call originates at the cellular radio, the radio scans the access channels and tunes to the strongest one. On that channel then the radio notifies the central controller of its identity and the number it wants to be connected to. From that point the process by which the cellular radio is assigned a voice channel and the call completed is the same as previously described.

### 3.0 TESTING CELLULAR RADIOS

To ensure satisfactory operation of the cellular radio, the transceiver controller function, the digital and analog signaling functions, the transceiver operation, and the information contained in the Number Assignment Module (NAM) must be verified. Since the transceiver functions are handled by a microprocessor based controller, the first functional block to be checked must be that controller. Most radios, and especially AMPS compliant radios, perform a basic self test of the radio when first powered up. If the self test is successfully completed, the handset indicators are activated. If the controller is not working, the indicators will either not activate or will activate in an abnormal manner. A faulty controller will probably prevent further troubleshooting until it is either replaced or repaired.

Once past the self test, the cellular radio will attempt to locate a forward control channel (FOCC). At this point the R2008C can be used to supply the FOCC signal modulated with the appropriate overhead control messages as a cell would on its data channel. A cradle 'no service' indicator will extinguish when the radio has successfully tuned to, decoded and responded to the FOCC signal.

---

A failure at this portion of the sequence would most likely indicate that the receiver or the receiver/controller interface circuitry has failed.

---

The manual test mode of the R2008C, which allows separate control and monitoring of the receiver, transmitter, and controller status, can be used to isolate the source of the failure.

With the cellular radio in service, either the call origination or the call reception capability of the radio can be checked. With the R2008C, the signaling exchange necessary to execute both sequences can be generated with the proper responses automatically checked for accuracy. Error messages are provided in the event that the radio does not respond properly. These messages and the manual test capability can then be used to isolate the cause of the failure.

---

Failure at this point would most likely be in the transmitter or data generating circuitry as the receiving circuitry had to be working to get an 'in service' indication.

---

A successful call origination or call reception test will end with the radio on a voice channel. On the voice channel the radio detects and checks for the correct SAT frequency, and then transponds the SAT signal on the reverse voice

channel. It is necessary to verify that the radio correctly identifies the SAT frequency and that it correctly transponds the signal. The R2008C again handles this verification automatically with error messages being provided in the event of a failure.

Other functions to be checked on the voice channel are transmitter power output and control, transmit frequency error, and modulation limiting. Each of these functions is easily checked with the R2008C with the data readouts provided on the cellular control display. Power, frequency error, and modulation checks on other channels is implemented with the use of the channel handoff capability. From the cellular control display, the signaling necessary to cause the radio to move to any cellular channel can be initiated. For the handoff, the R2008C verifies the response from the radio, and once on the new channel, verifies the correct SAT response. Again, error messages are generated in the event of a failure and with the manual test mode can be used to isolate the cause of the failure.

Finally, the R2008C can verify the termination sequence again with appropriate error messages in the event of a failure. User unique information such as home system identification number, telephone number, and control head lock code can be read from the NAM using the manual mode. This information will be required when servicing any cellular radio.

#### 4.0 R2008C Test Capabilities

Cellular testing capability has been made possible in the R2008C by the replacement of one module and the addition of another over the R2001C system analyzer (see note). The new microprocessor board has a Motorola 6809 microprocessor and additional decoding capabilities. A new cellular option board is added that performs the RF and manual interfacing to the cellular telephone transceiver unit. It controls the modulation of digital messages, audio and SAT tones by using the microprocessor to command the cellular radio.

The cellular option board also decodes the digital messages returned by the cellular telephone. This includes synchronizing on the dotting sequence and the word sync sequences at the start of these messages and decoding the Manchester encoded data in the message stream. The recovered digital information is then sent to the microprocessor board for processing. The cellular board also detects the presence of the 10 kHz tone sent by the cellular telephone, and can measure its duration. It does the necessary routing of SAT tones and audio.

Although the R2008C can transmit only one frequency at a time, it can switch frequencies at a relatively fast rate, making it ideal for multiple frequency checks necessary for more complete cellular testing. Once the desired channel numbers are selected in the initial parameters screen, the R2008C automatically switches its transmit and receive frequencies to simulate transition from a forward control channel to a forward voice channel, or from one voice channel to another, to simulate a cell handoff.

The digital messages are modulated onto the duplex generator automatically by the R2008C. Digital responses are decoded and analyzed to verify that the correct message has been sent back by the cellular telephone. Necessary data is extracted for verification, processing and display.

The required SAT frequency is produced by the R2008C, and the transponded SAT is checked. The three SAT frequencies, (1,2 & 3), are 5970, 6000 and 6030 Hz.

The 10 kHz signaling tone sent by the cellular telephone is measured by the R2008C to confirm successful handoffs, alert and release.

While in the voice channel, the frequency error, the output power and the peak deviation of the cellular telephone's carrier is constantly updated and displayed on the screen of the R2008C.

Extensive software has been written to exercise the cellular telephone in a variety of ways. Motorola's approach to cellular testing has been to keep testing as simple and comprehensible as

possible without sacrificing capability. In keeping with this ideal, a thermometer style display is used that 'fills in' as the test progresses. Help messages can be shown that spell out the definition of each square in the thermometer display. If a problem is encountered, warning and error message numbers are displayed. Temporary exits are allowed so that the power of the other R2008C modes can be utilized.

The software version numbers for the 9 files that comprise the R2008C software can be seen if a zero key is held down while the R2008C is turned on. This version number display will stay on the screen for 10 seconds; then normal operation ensues.

A manual test mode allows the operator to command the cellular telephone with any one of the 43 commands defined by the Advanced Mobile Phone Service (AMPS) specification of May, 1983.

The following sections describe how to physically set up a test, using the RF interconnect, or the manual test interconnect. Also included are operator instructions on how to use the cell and mobile initiated tests, the manual test mode and the auto test mode. A list of possible warnings and errors is included in Appendix E.

NOTE: The modification from an R2001C to an R2008C is performed at the Motorola Test Equipment Service Center.

#### 4.1 Setup Instructions

Connection from the R2008C to the mobile unit require accessories included in separate kits.

- RPX-4271B - Variable RF coupler  
Junction box  
Printer/junction box cable  
TNC-BNC adapter
- RPX-4272A - Adapter cables for junction  
Box to AMPS type radios
- RPX-4273B - Adapter cables for junction box  
to Motorola DYNA-TAC model T19ATA8822AE  
radios.
- RPX-4274A - Adapter cables for junction box  
to CT series radios.

#### SIGNALLING SEQUENCE TEST CONNECTION.

The signalling sequence test mode requires an RF connection be made from the R2008C to the mobile unit. To couple the output from the duplex generator to the main RF in/out connector, a variable tap RF coupler 58-80313B37, is used. Connect the male N connector on the coupler to the R2008C RF in/out port. Connect the variable tap to the duplex generator output with a short length of BNC to BNC coax 01-80350A46. Connect the female N connector on the coupler to the mobile unit antenna connector. A TNC to BNC adapter, 58-80313B33, may be required to connect to the mobile unit. See figure 1.

It is sometimes useful to access some test points on the control head to transceiver interface during the signalling test mode. This is accomplished by using the cellular junction box RTL-4137A and the adapter cables included in either RPX-4272A or RPX-4273B.

#### MANUAL TEST MODE CONNECTION.

The manual test mode requires that the R2008C seize control of the transceiver unit by making connection directly to the control port on the mobile unit. The printer/junction box cable is connected to the 24 pin connector on the rear panel of the R2008C, and to the 50 pin connector on the cellular junction box. The junction box is then connected to the mobile with an adapter cable from either the RPX-4272A or RPX-4273B accessory kit. The antenna connector on the mobile can be connected either to an external antenna for monitoring purposes, or to the R2008C directly into the RF in/out port or via the variable RF tap for duplex measurements. See figure 2.

SIGNALLING CONNECTION  
FROM R2008C TO CELLULAR TRANSCEIVER

FIGURE 1

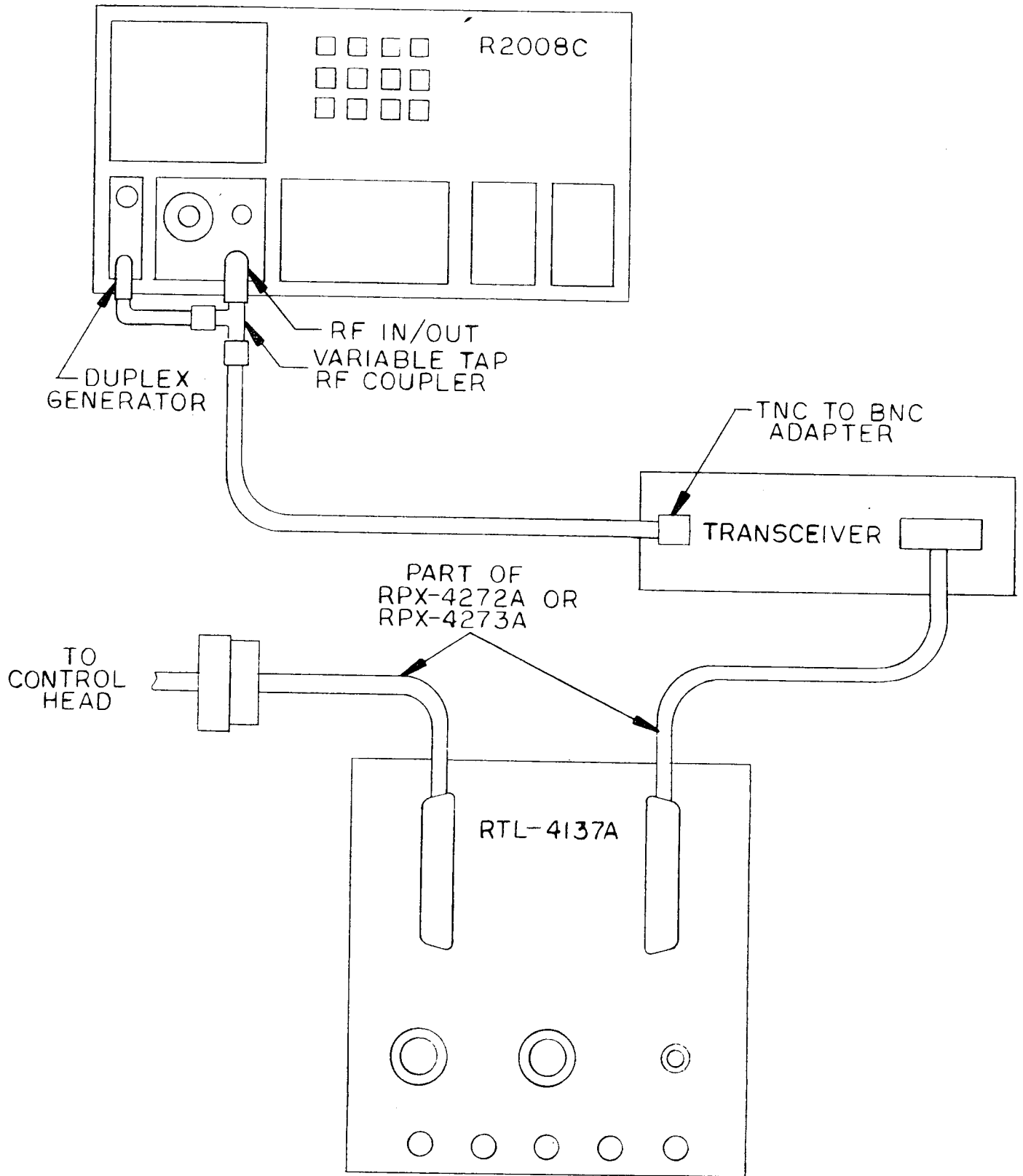

## 4.2 Operating Instructions

### Front panel selections for cellular testing

Before initiating cellular testing, make the following adjustments and switch selections on the R2008C front panel. They are:

1. Set the DUPLEX GEN switch to 45 MHz
2. Set the RF Step to -50 dB.
3. Set the RF Scan to 0.
4. Set the DISPLAY led to Tone Memory.
5. Set the FUNCTION switch to Pwr Mon.
6. Set the MODULATION Cont/Off/Burst switch to Off.
7. Use the FM FUNCTION state.
8. Set the BW (BandWidth) switch to Wide.
9. Set the Image/Dplx switch to High.
10. Adjust the Squelch level to near threshold.  
(Turn counter-clockwise until the Sig Lvl light comes on, then back off a small amount).
11. Set the variable RF tap to 1/4 to 1/2 inch.

### THE CELLULAR TEST SCREENS

The cellular test is accessed via the tone memory display. Enter '5' in the 'mode sel' position to access the cellular test screens. See figure 3. There are now 5 sub-selections possible. To access them, move the cursor down to the 'seq sel' position. The 5 selections possible are described in the following paragraphs.

FIGURE 3. TONE MEMORY DISPLAY

TONE MEMORY	MODE SEL) 5
1) A/B SEQ	3) MOBILE TEL
2) 5/6 TONE	4) SELECT V
	5) CELLULAR
CELLULAR	SEQ SEL) -
1) INITIAL PARAMETERS	
2) SEQ TEST, CELL INITIATED	
3) SEQ TEST, MOBILE INITIATED	
4) MANUAL TEST MODE	



## INITIAL PARAMETERS

This screen allows for the entry of basic parameters concerning the cellular telephone under test and selections the operator desires. See figure 4. Entries must be made here in order to use any of the cellular signalling sequence tests. Selections are stored in non-volatile memory and are saved even if the analyzer is powered down.

FIGURE 4. INITIAL PARAMETERS DISPLAY

CELLULAR INIT PARAM	SEL) -
1) EXIT	
SYSTEM ID )000002	
MOBILE ID )312 576 5444	
FOCC )334	
FVC 1)500 2)392 3)450 4)560	

**SYSTEM ID:** Enter the system ID of the cellular telephone under test. Entering a SID that does not match the one of the cellular telephones under test will force the telephone to go into the roam state. The SID is a 15 bit binary number entered in decimal.

**MOBILE ID:** Enter the telephone number of the cellular telephone under test. Entering a MIN that does not match that of the radio under test will prevent the cellular telephone from being called in the cell initiated test. The mobile initiated test will update this field.

**FOCC:** Enter the number of the desired forward control channel. Cellular radios scan channels 313 to 354. Those units configured for operation in a nonwireline carrier system consider channels in the range 313 to 333 as home data channels. those units configured for operation in a wireline carrier system consider

the range 334 to 354 as home channels. However, for test purposes, any channel from 1 to 666 may be entered. A channel selection of 334 will result in the transmitted frequency of 335.02 MHz from the R2008C. This is derived from the equation  $(825.00 + .03 \times (\text{channel number}) \text{ MHz})$ .

FVC 1-4: Enter the forward voice channels desired. These four channels will be used to simulate cell to cell handoffs during the signalling sequence screens. Also, FVC 1 is used as the first channel in the Auto Test sequence.

SEQUENCE TEST, CELL INITIATED

The cell initiated sequence test is designed to test the calling sequence when the R2008C (simulating the cell site) initiates a call to the cellular telephone. The necessary sequence of events includes sending from the R2008C overhead messages, a paging message, an initial voice channel designation message, power level command messages and handoff messages. The testing also requires that the digital and signaling tone responses to these commands be processed and checked.

FIGURE 5. CELL INITIATED SEQUENCE TEST DISPLAY

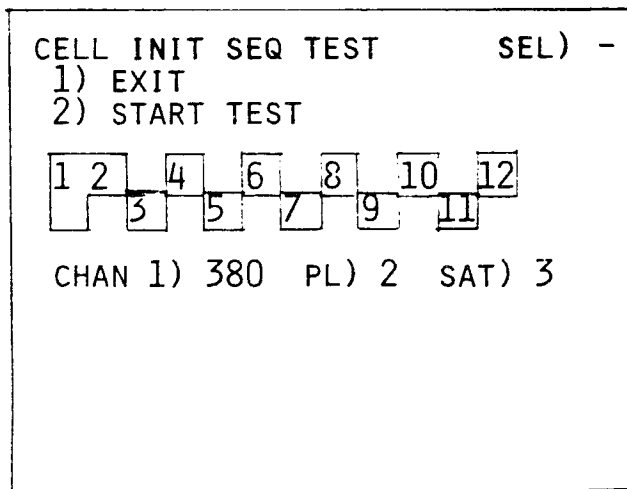

To aid the operator in visually verifying the progression of the test is a thermometer style sequence display. It will fill in from left to right as the test progresses. Refer to Fig. 5. Help messages are available describing each step in the calling sequence.

To view the help messages: Move the cursor underneath the squares of the thermometer and advance the cursor to the right by keying any number 1 to 9. The appropriate help message describing that step will appear. The squares on the top row of the thermometer display indicate actions that will be taken by the R2008C during the test. The squares on the next line indicate actions that the mobile will take that are perceived by the R2008C. Note that the first square is always filled since the R2008C begins a FOCC data stream upon entry into the cell initiated sequence test screen.

The selections possible in the cell initiated test screen are 1) EXIT and 2) START TEST. These selections are possible if the cursor is in the home position at the top of the screen. A '1' will return the screen back to the tone memory screen. A '2' will start a sequence test.

If the cellular telephone is properly attached to the R2008C, the no service light (NO SVC) on the cellular telephone will go out after the R2008C has been in the cell initiated sequence test screen for about 5 seconds. This indicates that the cellular telephone has locked onto the FOCC data stream from the R2008C. Visually verify that the no service light has gone out before starting the sequence test. Then enter a '2' after the 'SEL' to start the test.

The R2008C will immediately start to execute the call sequence. As each step in the sequence is completed, the space above or below the square will 'fill in' in a thermometer style progression. If errors are detected, a warning will be displayed near the bottom of the screen if it is a non-fatal error, and an error message will be displayed if a fatal error. Upon starting the test, the R2008C will send a paging message to the cellular telephone, if the phone number entered in the Initial Parameters screen matches the cellular telephone's number, the cellular telephone will issue a page response message. The mobile ID and serial number will be extracted from this message. These values will be displayed as that message is successfully decoded.

Next, the R2008C will issue an initial voice channel designation message, telling the cellular telephone which channel to switch to for voice communications. The R2008C and the cellular telephone will now transmit on the forward voice channel (FVC) and the reverse voice channel (RVC), respectively.

The R2008C now produces a Supervisory Audio Tone (SAT), which the cellular telephone is to transpond. The R2008C will check this SAT for correct frequency. The R2008C will then send an alert order, causing the cellular telephone to ring.

If the cellular telephone is answered at this point the test will progress into the conversation mode part of the sequence. However, the operator may use a temporary exit to observe waveforms while the cellular telephone is ringing (it will ring for 65 seconds if unanswered).

The selections possible in the conversation mode are displayed on the screen. See figure 6 for a pictorial representation of this screen. A frequency error, power level and a deviation indication will also appear at the bottom of the screen and will be updated continuously. Deviation values will typically be about 10 kHz while the phone is ringing due to signaling tone modulation. Once answered, the signaling tone stops, and only SAT tone is transmitted. This produces a deviation of typically 2 kHz.

FIGURE 6. CELL INITIATED TEST RESULTS DISPLAY

```

CELL INIT SEQ TEST      SEL) -
 1) ABORT
 2) TEMPORARY EXIT

 1 2  4  6  8 10 12
 3  5  7  9 11

CHAN 1) 380  PL) 0  SAT) 3
MN 800-576-5444 SN 8205E045

ERR KHZ      PWR W      MOD KHZ
+ 0.24      0.89      2.12
  
```

Move the cursor down and over to the 'PL' label and select power levels 0 to 7 to command the cellular telephone to any one of its 8 possible power levels. Key 0 is the highest power level and key 7 is the lowest power level. Pressing the key results in a power level order message being sent to the cellular telephone. An order confirmation will be sent back by the cellular telephone and checked by the R2008C. The output power in watts measured at the R2008C is shown at the bottom of the R2008C screen (keep in mind that the BNC cable and connectors will attenuate the power level). A temporary exit can be performed to analyze the signal using the other R2008C modes. Enter a '2' after the 'SEL' label to temporarily exit. Now use the display up/down buttons to use the R2008C'S other test modes.

---

Do not linger in the spectrum analyzer mode, however, as this will terminate the duplex output and the cellular telephone will drop out after 5 seconds for want of a SAT tone.

---

When the display is returned to Tone Memory, the software will lock in on the sequence test again. Another power level command can be initiated, and again the operator can observe a change in the power output reading or do a temporary exit to analyze the signal.

Voice communication is possible. Turn up the monitor volume on the R2008C and then talk into the handset of the cellular telephone. The operator should hear through the monitor speaker of the R2008C. Attach the microphone supplied to the R2008C Mic input and turn up the Ext Level gain control. Key the microphone and talk into it. This should be heard in the handset of the cellular telephone.

To handoff to the forward voice channels defined in the Initial Parameters screen, position the cursor after the 'CHAN' label. Entries 1 to 4 are used to simulate moving from one cell area to another. To handoff to FVC #2, enter a '2' on the R2008C. To handoff to FVC #4, enter a '4'. Handoffs can be performed as many times as desired, in any order. The 50 msec signaling tone response generated by the cellular telephone is measured for duration and an error message is shown on the R2008C if out of limits. Every handoff will automatically rotate the supervisory audio tone (SAT). Handoffs to the same FVC will result in a new SAT tone only.

A SAT drop test can be performed by entering a SAT value other than the one shown (selections are 1 to 3). The mobile was told to expect a specific SAT tone during the last voice channel designation order. If the mobile hears a different SAT, it thinks it has wandered into coverage from another cell, so it first mutes its transmit and receive audio and after 5 seconds, (a fade allowance), it stops transmitting to avoid interfering with the other cell.

To terminate the test from the mobile, either hang up or press the 'END' key on the handset. The R2008C will measure the duration of the termination (1.8 sec) 10 kHz signaling tone generated by the mobile.

To terminate the test from the R2008C, enter a '1' (End) on the top line of the display.

For a detailed description of the cell initiated sequence test steps, see appendix A and C.

SEQUENCE TEST, MOBILE INITIATED

The mobile initiated sequence test is similar to the cell initiated test except the cellular telephone is placing the call. This screen is accessed through the main Tone Memory screen. See figure 7.

FIGURE 7. MOBILE INITIATED SEQUENCE TEST DISPLAY

```
MOBILE INIT SEQ TEST   SEL) -  
1) EXIT  
2) START TEST  
  
1  TL3  5  7  9  
2      4  6  8  
  
CHAN 4) 560  PL) 0  SAT) 3
```

The selections possible are 1) EXIT, and 2) START TEST. These selections are possible if the cursor is in the home position at the top of the screen. A '1' will return the screen back to the Tone Memory screen. A '2' will start the test.

Help messages describing the blocks of the thermometer sequence can be accessed by moving the cursor to the line underneath the squares and advancing to the right by keying any number 1 to 9. The squares on the top row of the thermometer display indicate actions that will be taken by the R2008C during the test. The squares on the next line indicate actions that the mobile takes are perceived by the R2008C. Note that the first square is filled in since the R2008C begins an FOCC data stream upon entry into the mobile initiated sequence test screen. The cellular telephone should scan onto the data stream and the 'NO SVC' light should go out. If a foreign system ID was entered, the 'ROAM' light will light.

The test can be started at any time. Once commenced, the R2008C will wait for a service request from the car phone. Enter the number to be called into the cellular telephone. Allow the 'NO SVC' light to go out, then depress the 'SEND' key, the R2008C will receive the service request message and display the

called address on the CRT screen. Verify that the called address matches the one sent. The mobile ID and serial number are also extracted from this message and displayed on the CRT screen. The mobile ID is also used to update the Initial Parameters data. The R2008C now sends an initial voice channel designation message. The R2008C and the cellular telephone will switch to the first FVC and RVC channel respectively. See figure 8. Just as in the cell initiated test, voice communications can be verified, temporary exits are allowed to analyze the signal, handoffs are allowed to any one of the four preselected forward voice channel frequencies, power level changes can be commanded or the SAT can be changed to force a telephone drop out. And, as in the cell initiated test, the call can be terminated either by pressing the 'END' key or by entering a '1'(End) on the top line of the display.

For a detailed description of the mobile initiated sequence test steps, see appendicies B and D.

FIGURE #8 MOBILE INITIATED TEST RESULTS SCREEN

MOBILE INIT SEQ TEST				SEL) -
1) ABORT				
2) TEMPORARY EXIT				
1	TL3	5	7	9
2	4	6	8	
CHAN 4) 560 PL) 0 SAT) 3				
MN 800-576-5444 SN 8205E045				
TEL NO 800-867-5309				
ERR KHZ PWR W MOD KHZ				
+ 0.34 1.46 2.12				

## MANUAL TEST MODE

The manual test mode is accessed by a '4' entry at the 'SEQ SEL' position on the Tone Memory screen. See Fig. 9. This mode allows the operator to enter and send any one of the 43 commands to the transceiver unit of the cellular telephone as defined by the AMPS spec of May, 1983.

FIGURE 9. MANUAL TEST DISPLAY

```
CELLULAR MANUAL TEST   SEL -  
 1) EXIT  
 2) START  
COMMAND) 33 SATOFF  
ENTER    0 BYTES
```

Move the cursor down to the command line. Enter the desired command. The R2008C will display a mnemonic describing the command. If the particular command requested requires additional bytes, dashed lines will indicate where they should be entered on the screen. See Fig. 10. If this is the case, move the cursor over to the dashed lines and make the necessary entries. If hexadecimal data is required, use the normal 0-9 keys, but in addition, use the 'up/down' keys of DISPLAY, FUNCTION and MODULATION to obtain A-F. The 'up/down' keys of DISPLAY are used for A and B. The 'up/down' keys of FUNCTION are used for C and D. The 'up/down' keys of MODULATION are used for E and F.



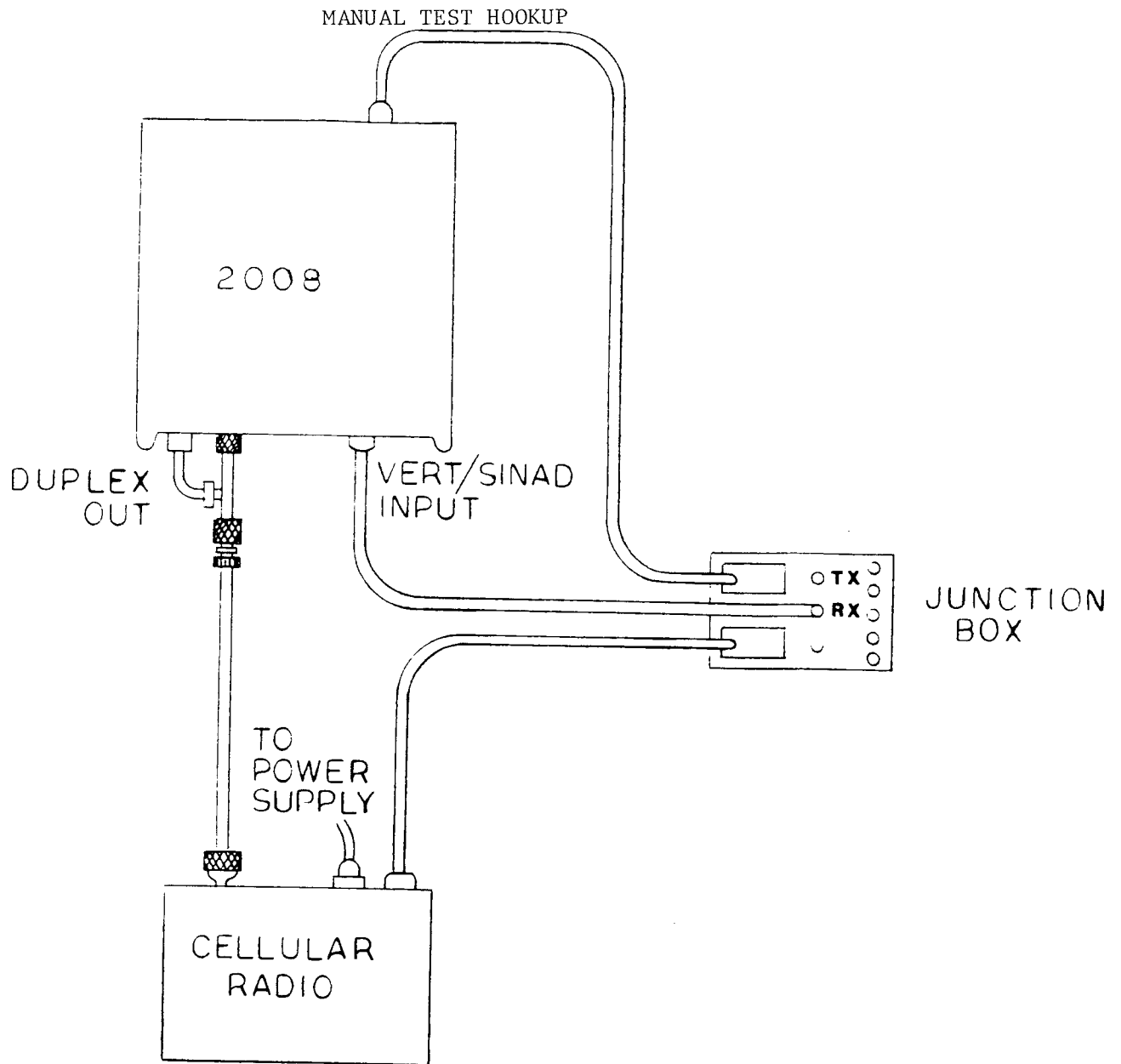

FIGURE 10. MANUAL TEST DETAILED DISPLAY

```
CELLULAR MANUAL TEST   SEL) -  
 1) EXIT  
 2) START  
COMMAND) 34 CDATA  
ENTER   6 BYTES      --  
-----
```

To send the command to the transceiver unit, return the cursor to the home position and enter a '2'. The command will then be sent along with any additional bytes required. The operator is now free to send additional commands or to exit the screen and measure parameters using the other R2008C test modes.

If the command sent requires that the cellular telephone return information, the R2008C will display the returned data automatically.

If failures occur in the handshaking procedure, an error message will be displayed on the bottom of the screen.

---

Normally, the first command entered is an 01 (SUSPEND) command to set the transceiver into the test mode so that the other commands can be utilized. Otherwise, only STATUS, TURNAROUND, RESET, RESTART and SUSPEND will function.

---

Repeats of the same command can be made by holding in the '2' key while the cursor is in the home position.

For a list of the 43 possible commands, see appendix F.

## 5. AUTO TEST MODE

The Auto Test Mode enables a technician to test a cellular radio on as many channels as desired. The R2008C signals the radio under test as in the sequence tests. Measured values of frequency error, output power and modulation deviation are displayed for each channel tested, and recorded on an optional printer. The following sections describe how to set up and operate the R2008C in the Auto Test Mode.

### INITIAL PARAMETERS

Select the INITIAL PARAMETERS screen by keying a 1 in the main Tone Memory screen.

SID Enter the System ID that the mobile expects. If incorrect, or if not known, the mobile will still function but the mobile will give a ROAM indication.

FOCC Enter the FOCC (data channel) desired. The mobile will scan the channels 313-354. Mobiles configured for wireline carriers consider the range 334-354 as their home system range. Mobiles configured for nonwireline carriers consider channels 313-333 as their home system range.

FVC 1) This channel is the first in the series of channels to be tested. The other three FVC selections are used only in the cell and mobile initiated sequences.

FVC INCREMENT This parameter specifies the channel spacing for the automatic handoffs. So if this is 100, then every 100th channel will be checked.

PRINTER (1=YES, 0=NO) Select a 1 if a printer is desired, and select 0 if not. The printer is required to have RS232, 1200 baud capability. See Appendix G. for instructions on setting up the optional Epson RX-80 printer, Motorola part no. RT-RX80/8148.

### AUTO TEST OPERATION

Connect the R2008C Mod Out jack to the Tx Audio jack on the junction box.

On the main Tone Memory screen, key in selection 5 to access the auto test mode. The screen will instruct the operator to adjust the 1 kHz level for a 2.0 to 2.5 volt output. The purpose of this is to input sufficient signal so the transceiver will begin to go into deviation limiting on each channel tested.

Key in a 2 to begin the test.

A WAIT message will be displayed as the R2008C adjusts the 45 MHz offset. At this point, the R2008C is sending out an overhead message stream on the FOCC, as a cell would.

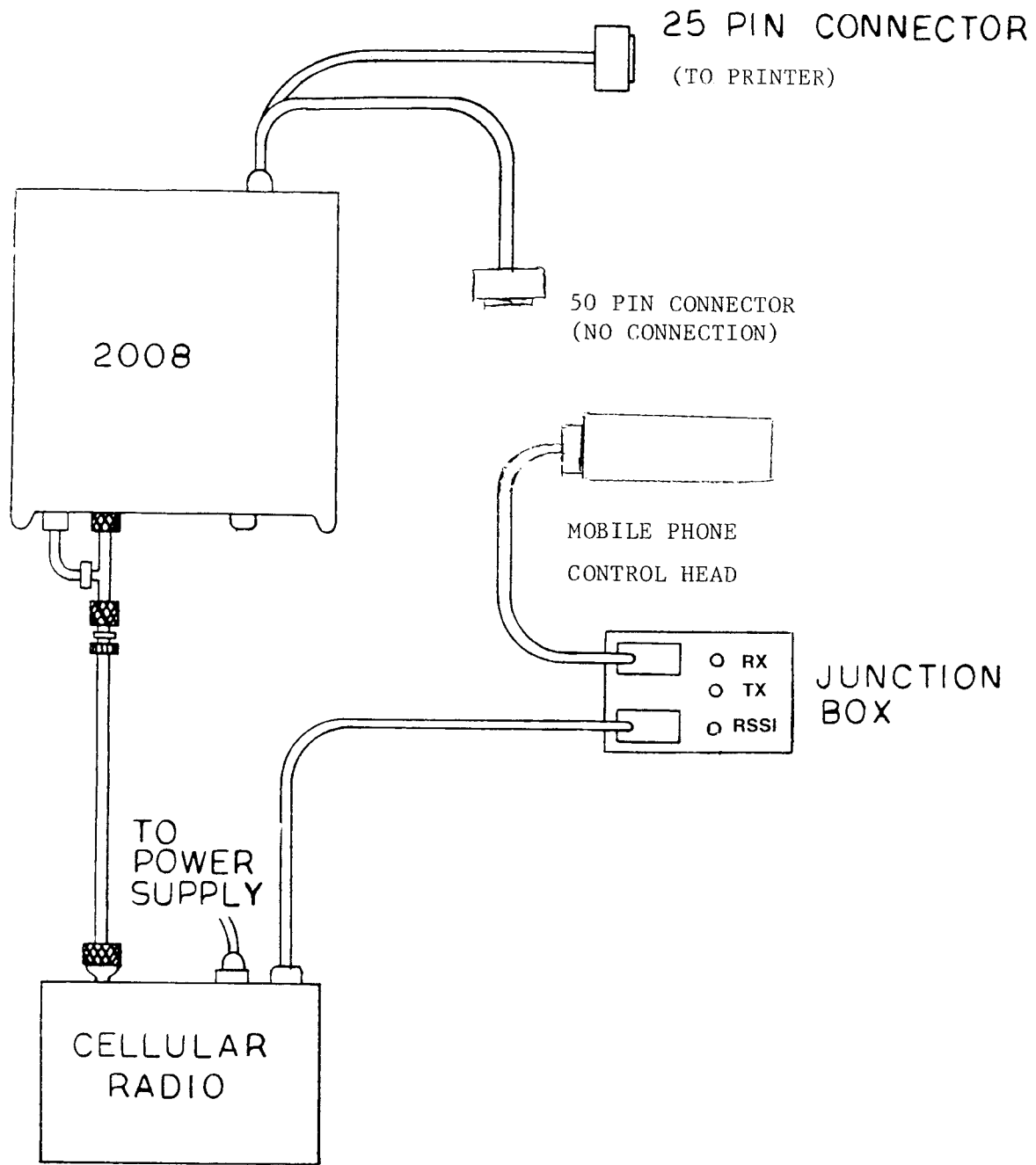

AUTO TEST HOOKUP

This portion of the sequence is very similar to the MOBILE INITiated test described earlier. The R2008C is waiting for a service request message from the mobile under test. The R2008C now will display a SEND TEL # WHEN IN SVC message. When the NO SVC indicator on the car phone goes out, start a call from the mobile.

The R2008C will now display SAT deviation (not from the 1 kHz Mod Out), output power and frequency deviation of the mobile on FVC #1. The R2008C will wait for the data to stabilize, and then print it out if a printer was selected. Then, the R2008C will issue a release order to the mobile, and resume transmission of overhead data on the FOCC.

After a short delay, to allow the mobile to firmly lock onto the data stream, the R2008C will page the mobile using the Mobile ID number sent by the mobile in the earlier part of the test. When the mobile begins to ring, the operator has 10 seconds to answer before the 10 kHz signalling tone interferes with the SAT and deviation measurements.

The R2008C will now display frequency error, power output and 1 kHz modulation deviation from the mobile under test.

After a short delay, to allow the data to stabilize, the R2008C will execute handoff orders to step the mobile through the FVC range up to channel 666. The R2008C will display and send the measured data to the printer for each channel tested.

By looking at trends in the data over the range of channels, a troubleshooter will be able to narrow down the faulty functional blocks in the mobile under test, as well as provide a historical record of the mobile for customer assurance.

## 5.0 APPLICATION NOTES

### A. RECEIVER AUDIO LEVEL TESTING

- 1) Connect R2008C to transceiver unit via junction box.  
(Refer to Fig. 12.)
- 2) Disconnect duplex generator output if connected.
- 3) Select generator function and execute the following manual mode commands:  
01 Suspend  
09 Load synthesizer (enter desired channel)  
12 RX unmute
- 4) Set R2008C to desired channel (870 MHz plus .03 X channel #)  
ex. 879.99 MHz equals channel 333.
- 5) Connect RX audio BNC connector on junction box to Vert/Sinad input on R2008C.
- 6) Select GEN function on R2008C. Adjust the output level to -50 dBm to simulate a strong signal. Adjust 1 kHz modulation level to 2.9 kHz deviation.
- 7) With junction box compandor switch in NORMAL mode, adjust radio for 100 mV RX audio while in DVM/DIST display on R2008C. Set the compandor switch to BYPASS and adjust radio again for 100 mV.
- 8) Increase 1 kHz deviation to 8 kHz, read distortion in either DVM/DIST or GEN/MON display.
- 9) Data distortion: Using DVM/DIST display, and with modulation still 1 kHz at 8 kHz deviation, measure level at discriminator test point (junction box test point for AMPS bus compliant radios, internal radio test point for others). Using tone memory display, input 9999.9 Hz for tone A. Turn 1 kHz modulation off. Adjust code synth output for 8 kHz deviation using tone A and note level at radio discriminator. Difference in level from that noted with 1 kHz modulation should be less than 3 dB.
- 10) Audio frequency response: Bypass the transceiver compandor. Use the Tone Memory display to set tone A to 300 Hz, and tone B to 3000 Hz. Using a constant deviation level of 2.9 kHz check the level at the RX audio jack. Typical output levels are:

300 Hz	331 mV
1000 Hz	100 mV (REF)
3000 Hz	33 mV

AUDIO RESPONSE IS -6 dB/OCTAVE DEEMPHASIS

FIG. 12

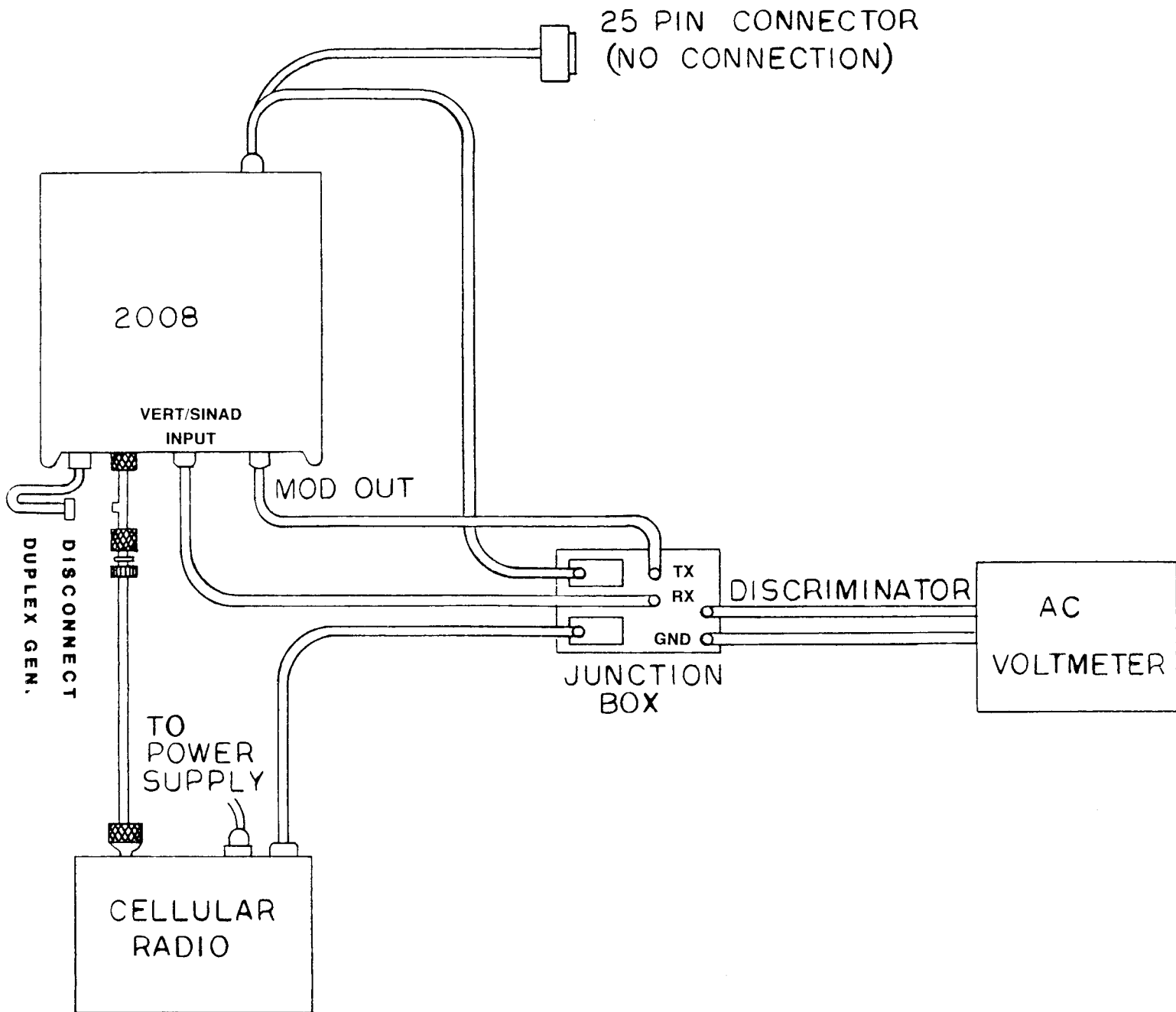

## B. TRANSMITTER DEVIATION

- 1) Connect R2008C to transceiver unit via the junction box, as in manual test mode connection. (Refer to Fig. 12.)
- 2) Select power monitor mode and execute the following manual mode commands:
  - 01 Suspend
  - 09 Load synthesizer, enter desired channel
  - 07 Carrier on
  - 14 TX unmute
- 3) To check deviation, connect mod out jack to TX audio connector on junction box. Set either 1KHz level or code synth level using modulation display and observe deviation on GEN/MOD display. Use Tone Memory display to vary frequency of tone A or tone B to check deviation on frequencies other than 1 kHz. Send manual mode command 13 TX mute to mute transmitter audio for further tests.
- 4) Signalling tone deviation can be set by sending the manual mode command 16, Signalling Tone On, to the transceiver unit. Set deviation to 8 kHz measured on GEN/MON display. Manual mode command 17, Signaling Tone Off, will deactivate the transceiver signaling tone generator.
- 5) DTMF deviation can be set by executing manual mode command 42, DTMF On, and inputting desired digit such as 06. Adjust the transceiver for approximately 8.5-9 kHz deviation (roughly equal to 9 radians peak phase deviation).
- 6) SAT deviation can be set by executing manual mode command 32, SATON, and entering 01. Set SAT deviation to 2 kHz.



### C. RECEIVER SENSITIVITY

- 1) Connect R2008C to transceiver unit via the junction box.  
(Refer to Fig. 12.)
- 2) Execute the following manual commands:
  - 01 Suspend
  - 09 Load synthesizer (to desired channel)
  - 12 Receiver unmute
- 3) Connect RX audio (on junction box) to R2008C sinad input.
- 4) Set R2008C to generate on desired frequency (870 + channel # X 0.03 MHz), with 1 kHz modulation at 8 kHz deviation.
- 5) Bypass the compandor on the transceiver unit.
- 6) Adjust the RF output level on the R2008C for a 12 dB sinad reading in GEN/MON display.

NOTE: One can expect to see a difference of about 1 dB of RF level between a C-message weighted sinad measurement and a flat weighted sinad measurement on the R2008C, i.e. -115dBm on the R2008C corresponds approximately with -116dBm C-message weighted.

#### D. DUPLEX SENSITIVITY

- 1) Connect R2008C to transceiver unit via the junction box.  
(Refer to Fig. 13.)
- 2) Connect duplex generator output to variable tap on RF tee through a 60 dB attenuator (part no. 58-80314B21)
- 3) Set: Duplex gen to 45 MHz RF step to -50dB  
IMAGE/DPLX to high  
BW to wide  
Display to duplex gen  
Function to gen
- 4) Select desired frequency (825 MHz + 0.03 X channel #).
- 5) Using Duplex Gen display adjust the Duplex Gen vernier for 45 MHz offset. Adjust 1 kHz modulation for 8 kHz deviation.  
  
Set function switch to PWR MON.
- 6) Using manual test mode, send the following commands to the transceiver unit:
  - 01 Suspend
  - 09 Load synthesizer (input desired channel #)
  - 12 Receiver unmute
- 7) Connect RX audio on junction box to sinad input on R2008C.
- 8) Using DVM/DIST display, adjust variable tap on RF tee for 12 dB sinad.
- 9) Using manual test mode, execute command 07, Carrier On, to key the transmitter.
- 10) Check sinad reading on DVM/DIST screen. Sensitivity will degrade if transceiver has a de-sense problem.

FIG. 13

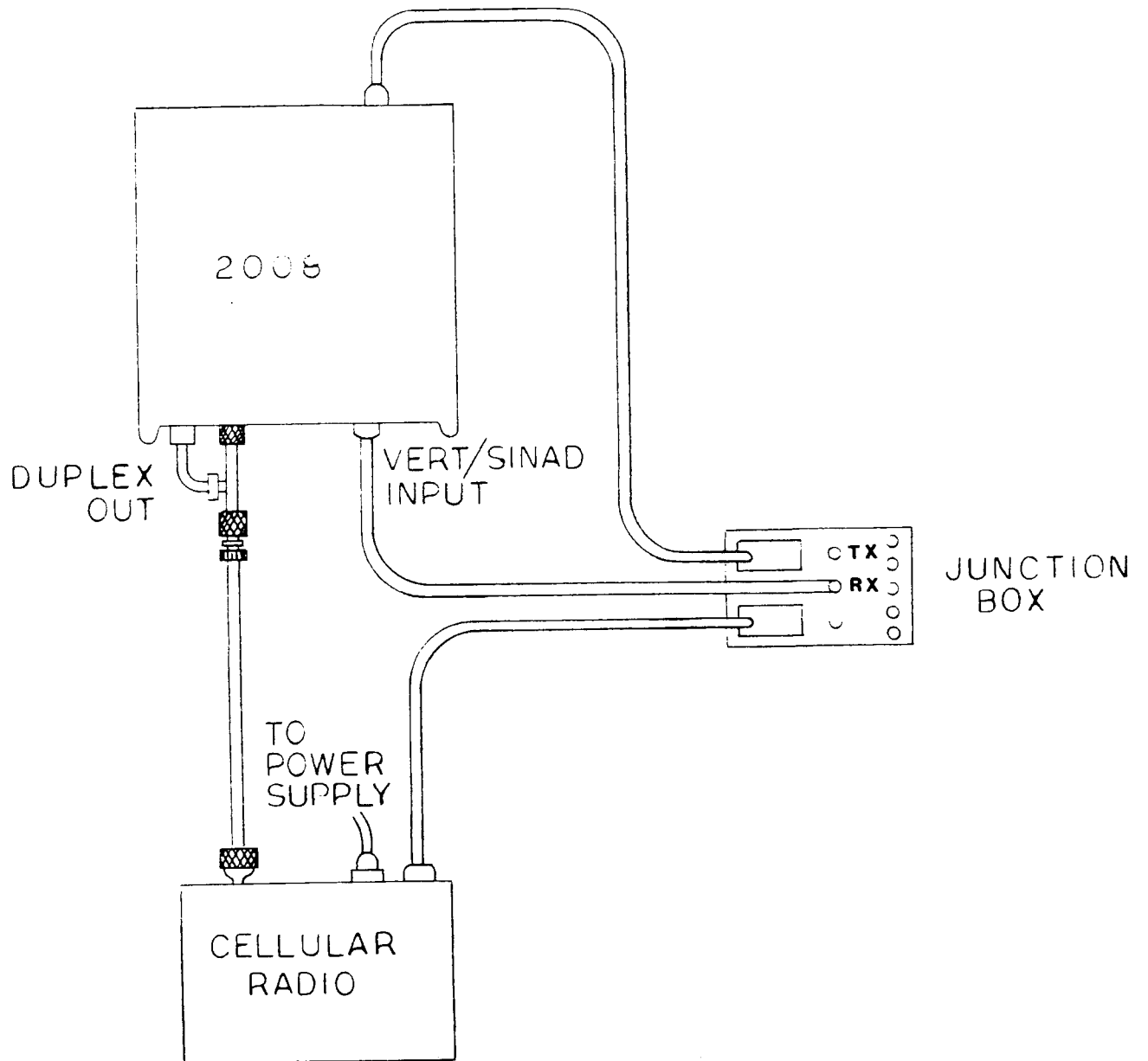

## E. POWER LEVEL SETTING

- 1) Connect R2008C to transceiver unit through the junction box. (Refer to Fig. 12.)
- 2) Set R2008C to Power Monitor. Through the manual test mode execute the following commands:

01 Suspend  
09 Load synthesizer (enter desired channel)  
07 Carrier on  
10 Set attenuator (set to 0 highest power)

NOTE: Power levels are as follows:

ATTENUATOR	WATTS	dBm
0	3.0	34.8
1	1.2	30.8
2	.48	26.8
3	.19	22.8
4	76mW	18.8
5	30mW	14.8
6	12mW	10.8
7	4.8mW	6.8

- 3) Note power level in Gen Mon display. For the lower power levels, use the R2008C spectrum analyzer.
- 4) Select the spectrum analyzer display and note the relative power level in dB.
- 5) In the Tone Memory display, execute manual mode command 10, Set Attenuator (select desired attenuation).
- 6) Determine power level by using the spectrum analyzer display. Note the relative power level in dB. Power output should decrease in 4 dB steps as transceiver attenuator setting is increased through the manual test mode commands.

## F. SAT PHASE

### Lissajous figure method

- 1) Connect R2008C to transceiver unit via the junction box.

Transceiver	Cable number
AMPS Complete	01-80356A33 (P/O RPX-4273B)
AMPS Compliant	01-80356A30 (P/O RPX-4272A)
CT series	RTK-4069A (P/O RPX-4274A)

(Refer to Fig. 14.)
- 2) Connect duplex generator to tap on RF tee.
- 3) Set analyzer to desired channel (825 MHz + .03 X channel #)  
eg. channel 333 equals 834.99 MHz.
- 4) Set Tone A for 6000 Hz.
- 5) With display in Duplex Gen position, adjust duplex generator fine frequency vernier to 45 MHz above monitor channel, e.g. channel 333 equals 879.99 MHz. Set function switch to Gen, select Code Synth mode, Tone A and adjust code synthesizer level for 2 kHz deviation on Duplex Gen display.
- 6) Set function switch to power monitor. Using Manual mode, execute the following commands:

01	- Suspend
09	- Load Synthesizer to desired channel
07	- Carrier on
32	- Saton (select SAT 01)
- 7) Using Gen/Mon display, adjust SAT deviation control in radio for 2 kHz deviation.
- 8) Connect Mod Out to Ext Horiz In with patch cable.
- 9) Connect Vert In to transceiver modulator test point.
- 10) Select scope AC display, Ext Horiz input.
- 11) Adjust horizontal and vertical gain controls until ellipse is just contained in 8cm by 8cm area on CRT, as shown in fig. 15. Ignore any noise present on the display.
- 12) Adjust SAT phase shift to make as narrow an ellipse as possible. An ellipse that has Y axis crossings 1.4 CM apart, as shown, represents a system phase shift of 10 degrees. A diagonal line represents a phase shift of 0 degrees.

FIG. 14

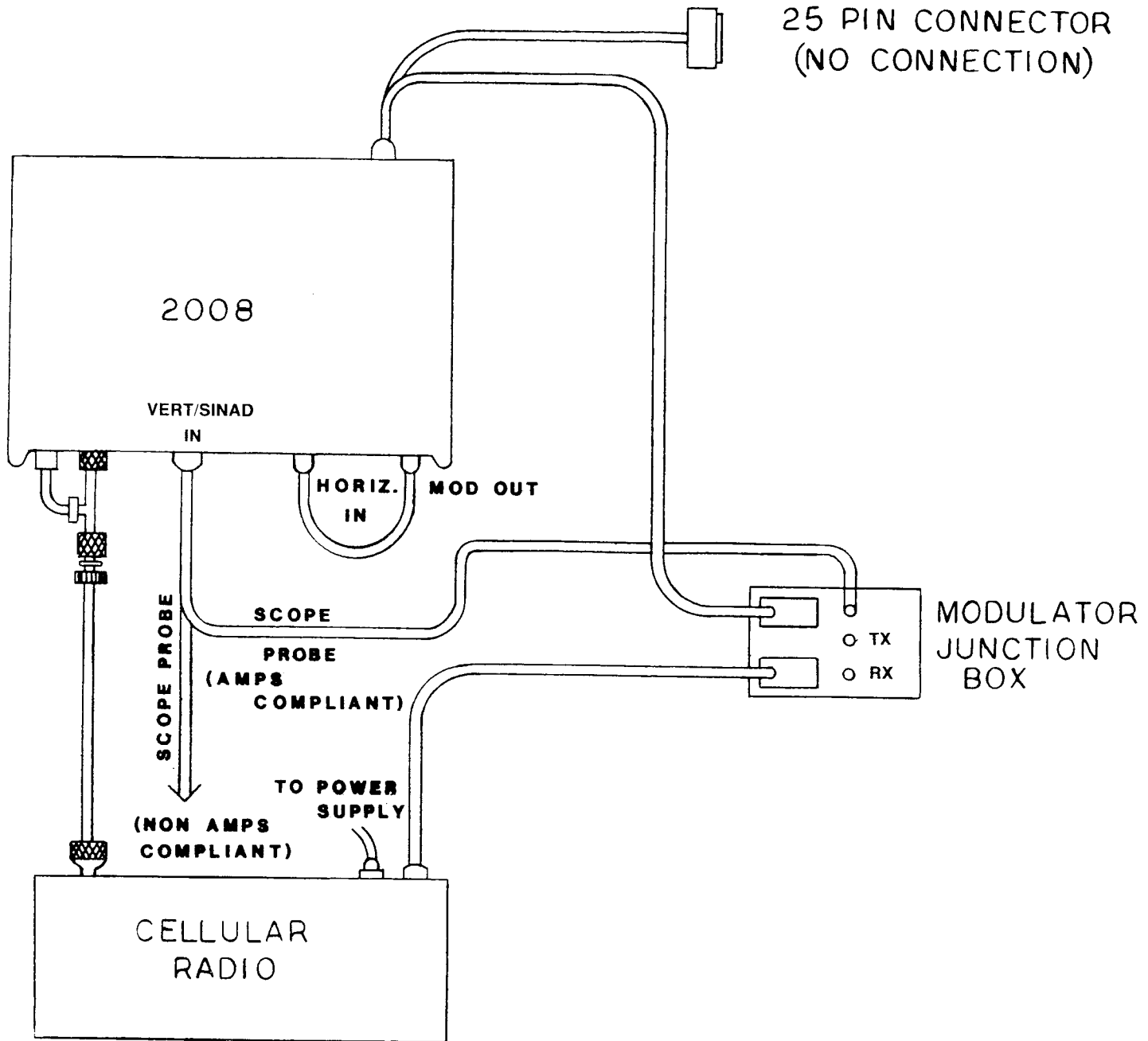

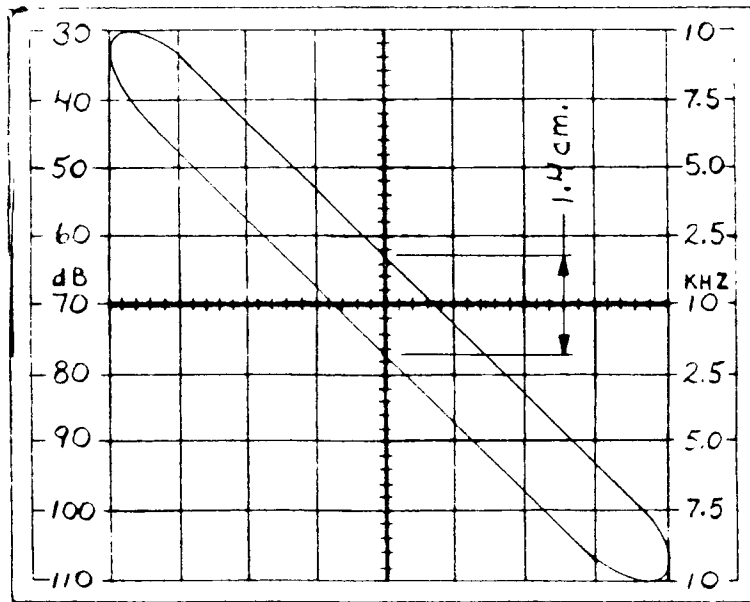

Fig. 15 SAT phase adjustment. Lissajous figure showing  $10^\circ$  of phase shift.

#### G. RSSI TESTING

The cellular mobile uses its RSSI (received signal strength indicator) to determine which FOCC is the strongest one, so it can lock onto the data channel from the nearest cell.

- 1) Connect the R2008C to the mobile via the junction box. (Refer to Fig. 16.)
- 2) Using the Manual Test mode, execute the following commands:  
01 SUSPEND  
09 LOAD SYNTHESIZER (input desired channel)
- 3) Connect the R2008C RF In/Out port to the mobile, and turn off the Duplex Generator. Select the desired frequency on the display (870 MHz + 0.03x channel #).
- 4) Set the R2008C to the DVM screen. Connect the Vert/Sinad input to the RSSI test point on the junction box. Adjust the RF step and vernier controls for the desired output level.
- 5) The transceiver RSSI voltage should start at from 0 to 0.5 volts with no signal. Rssi should start increasing with a -110 dBm input level and increase steadily up to at least -40 dBm input level.



FIG. 16

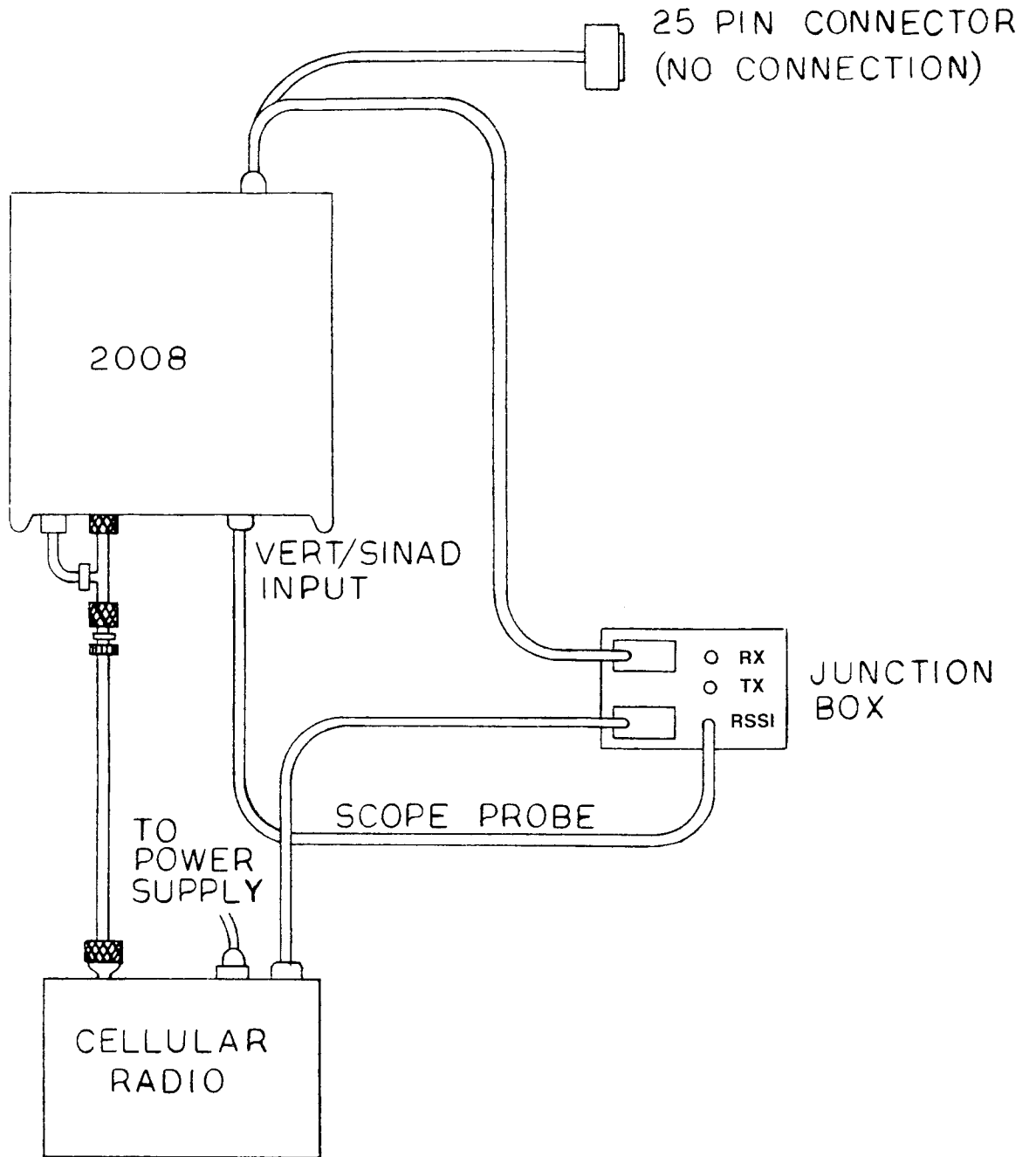

## H. TESTING SIGNALLING AT THRESHOLD LEVEL

It is sometimes desirable to verify the operation of the mobile under weak signal conditions. This can be done by using the following procedure.

- 1) Connect the R2008C to the transceiver unit via the junction box as in Fig. 12.
- 2) Turn off the Duplex Generator and disconnect the output from the Rf tee.
- 3) Select the Generator function and execute the following manual mode commands:
  - 01 SUSPEND
  - 09 LOAD SYNTHesizer (enter the desired channel)
- 4) Set the R2008C to generate on the desired frequency (870 MHz + 0.03 x channel #), ex. 879.99 MHz = channel 333.
- 5) Select the DVM display on the R2008C and use a scope or meter probe to access the RSSI test point on the junction box.
- 6) Set the output level on the R2008C to the desired signalling level. A -108 dBm level is the accepted signalling threshold level. Note the voltage at the RSSI test point.
- 7) Connect the R2008C to the transceiver unit via the variable RF tee as in the Cell and Mobile Initiated Sequence tests. Reconnect the control head to the transceiver unit.
- 8) Insert a 60 dB attenuator (part no. 58-80314B21) in series with the Duplex Generator output. Set the variable tap on the RF tee to fully in (maximum coupling).
- 9) On the Initial Parameters screen, select one of the Forward Voice Channels (FVC) to be the same as the desired FOCC (data channel).
- 10) Select either the Cell or Mobile Initiated Sequences. Execute the test and handoff to the FVC loaded with the FOCC channel above.
- 11) Using a temporary exit from the Tone Memory screen, select the DVM display. Monitor the RSSI voltage and adjust the tap on the RF tee for the same RSSI voltage noted earlier. The signal being fed to the transceiver unit is now at the desired threshold level.
- 12) Continue with any of the Cell Initiated, Mobile Initiated or Auto Test sequences to test the performance of the mobile under threshold signalling conditions.

APPENDIX A CELL INITIATED TEST STEP DEFINITION

The following illustration shows the major events in the Cell Initiated Sequence Test. The top line represents the forward, or from the base, data and SAT sequences. The lower line represents the reverse, or from the mobile, data and SAT exchange. The horizontal time axis is not to scale, this illustration is a conceptual overview of the handshaking that takes place in a cellular system.

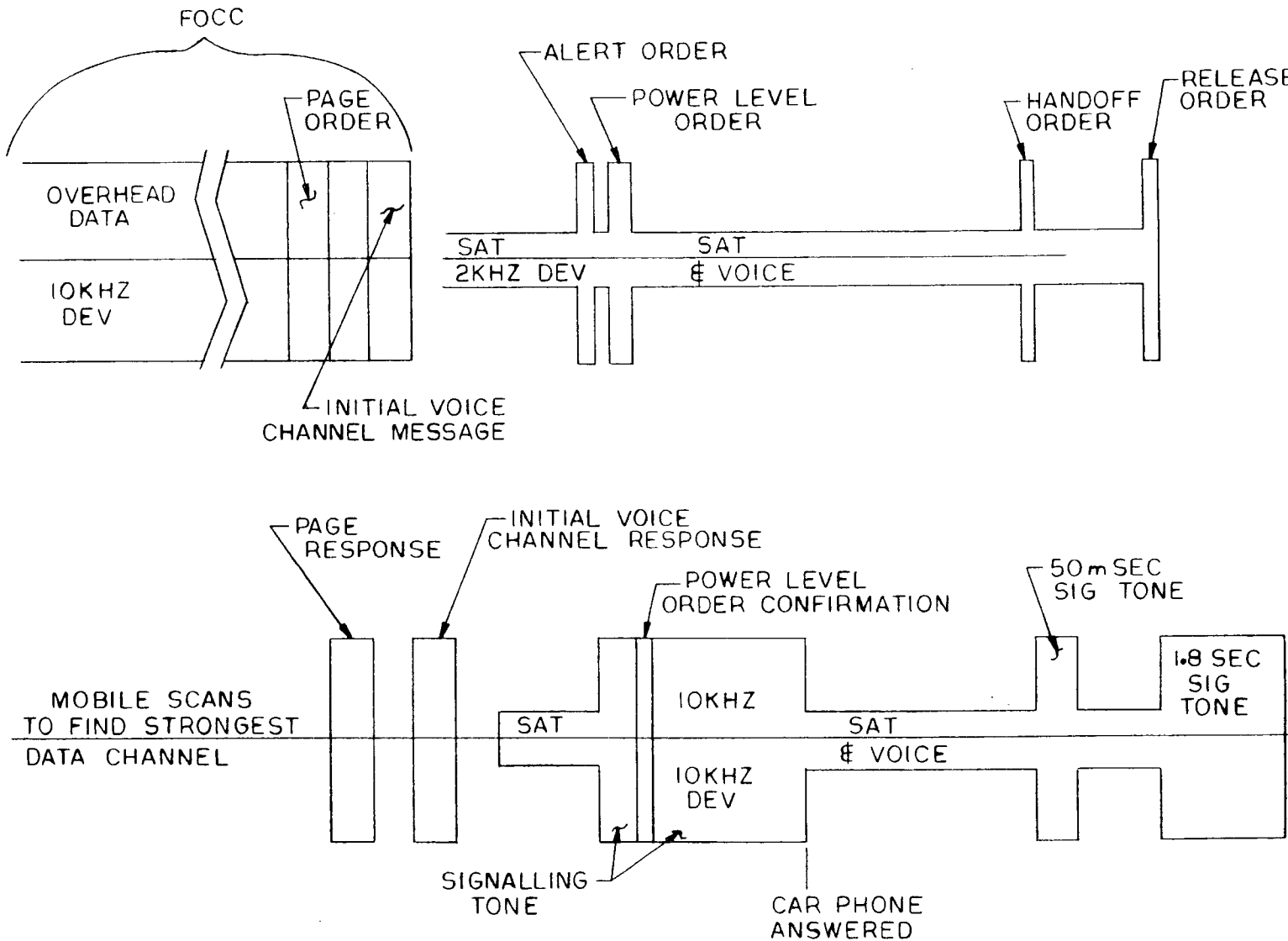

The following list corresponds to the step rectangles seen on the cell initiated sequence test screen, figure 5. The first sentence following each number is the help message that will be seen if the cursor is positioned under that test square on the R2008C display.

R2008 ACTIVATED

MOBILE ACTIVATED

1. FOCC-system parameter overhead messages sent. The R2008C sends a continuous stream of system parameter overhead messages to the mobile unit under test.
2. FOCC-paging message sent. The R2008C sends a paging message to the mobile unit under test. The paging message contains the mobile telephone number entered in the initial parameters screen.
3. Page response accepted. The R2008C perceives a valid page response from the mobile.
4. Voice channel designation message sent. The R2008C sends a message to command the mobile to a forward voice channel.
5. Sat accepted. The mobile and R2008C are now on FVC #1. The R2008C measures the SAT returned by the mobile to verify that it is the correct SAT.
6. Alert order sent. The R2008C sends out an alert order to command the mobile to start ringing.
7. Signaling tone accepted. The R2008C detects a valid signaling tone from the mobile verifying that the mobile has been alerted.
8. Power level command sent. A high power level command is sent by the R2008C to the mobile.

9. Power level order confirmation accepted. The R2008C has received an order confirmation from the mobile.
10. Power level and handoff testing normal conversation mode. The R2008C allows for manual power level testing of the other power levels possible from the mobile. Handoffs to the four possible forward voice channels can be made. A SAT drop test can be performed.
11. Release signaling tone accepted. The R2008C has received a termination signaling tone.
12. TEST COMPLETED.

APPENDIX B MOBILE INITIATED TEST STEP DEFINITION

The following corresponds to the test step rectangles seen on the mobile initiated sequence test screen, figure 7. The first sentence following each number is the help message that will be seen if the cursor is positioned under that test square on the R2008C CRT screen.

CELL ACTIVATED

MOBILE ACTIVATED

1. FOCC-system parameter overhead messages sent. The R2008C sends a continuous stream of system parameter overhead messages to the mobile under test.
  2. Service request accepted with called address. The R2008C accepts the service request message, displays the telephone number, the mobile and serial number from the mobile.

TL- Display called address.
3. Voice channel designation message sent. The R2008C sends a message to the mobile, instructing it to tune to a forward voice channel.
  4. SAT accepted. The R2008C measures the SAT returned by the mobile and verifies that it is correct.
5. Power level command sent. A high power level command is sent by the R2008C to the mobile.
  6. Power level order confirmation accepted. The R2008C has received an order confirmation from the mobile.
7. Power level and handoff testing, normal conversation mode. The R2008C allows for manual power level testing of the other power levels possible from the

mobile. Handoffs to the four possible forward voice channels can be made. A SAT drop test can be performed.

8. Mobile terminates RVC. The R2008C has received a termination tone from the unit under test.

9. TEST COMPLETED.

## APPENDIX C DETAILED CELL INITIATED TEST ACTIONS

The following describes in more detail what goes on in a typical cell initiated sequence test. It includes internal functions to the cellular telephone. This is only a brief summary. Refer to the AMPS specification for a more detailed description and to find the definitions of various acronyms used.

### R2008

### MOBILE

Enter initial parameters through the initial parameters screen of the tone memory mode.

SYSTEM ID  
MOBILE ID  
FOCC  
FVC #1 TO #4

Power up mobile. Mobile performs DC power up task.

Enter cell initiated sequence test screen. The R2008C starts to send a continuous stream of system parameter overhead messages.

Mobile performs initialization task

- A. Scan control channels.
- B. Tune to R2008C FOCC.
- C. Acquire word sync.
- D. Receive overhead messages.
- E. Update overhead information.

Perform paging channel selection task.

- A. Scan paging channels.
- B. Tune to R2008C FOCC.
- C. Acquire word sync.
- D. Receive overhead message.
- E. Perform overhead message processing task.

Enter idle task examine data for:

- A. Paging match.
- B. User request.
- C. Order.
- D. Overhead message.



Receive paging message.  
Perform page response task.  
A. Scan access channels.  
B. Tune to R2008C FOCC.  
C. Acquire word sync.  
D. Retrieve internal access parameters.  
E. Wait random delay.  
F. Seize RECC.  
G. Perform service request subtask.  
H. Enter await message subtask.

Accept page response. Extract mobile number and serial number and display on R2008C.

Send initial voice channel designation message.

Tune to FVC.

Perform initial voice channel confirmation subtask.  
A. Tune receiver to R2008C FVC.  
B. Adjust transmit frequency to RVC.  
C. Adjust rf power to VMAC.  
D. Turn on SAT.  
E. Set DSCMM to SCC.

Accept transponded SAT as an indication of mobile confirmation.

Enter waiting for order task.

Send alert order.

Receive alert order.  
A. Turn on 10 kHz signaling tone.  
B. Generate "ring".

Accept signaling tone (10kHz) as confirmation of alert order.

Enter waiting for answer task. A Maximum of 65 seconds allowed for answer.

Off hook (mobile is answered). signaling tone is turned off.

Enter conversation task

- A. Set audio mode to conversation
- B. Two way audio conversation now in progress.

Send power level command.  
High power.

Adjust power level to that requested and send order confirmation.

Accept order confirmation.  
Manual power level testing permitted.  
Select power levels 0-7.

Adjust power level to that requested and send order confirmation

Verify order confirmation.

Handoff testing permitted.  
select FVC.

Send a 50 msec signaling tone as a confirmation. Change to the new RVC.

Confirm 50 msec signaling tone time for the handoff.

Switch to the new FVC.

SAT drop testing permitted.  
Select a new SAT frequency (1-3).

If a new SAT selected, the mobile should stop transmitting after 5 seconds.

Repeat power level and/or handoffs above as desired.

Temporary exits allowed to analyze signals using the other R2008C modes.

On - hook (mobile hangs up).  
enter release task.  
A. Set audio mode to idle.  
B. Send signaling tone (10 kHz) for 1.8 seconds.

Receive termination signaling tone.  
Check for proper duration.  
End of cell initiated sequence test.

## APPENDIX D DETAILED MOBILE INITIATED TEST ACTIONS

The following describes in more detail what happens during a mobile initiated sequence test. Refer to the AMPS specification for a more detailed description.

### R2008

Enter initial parameters into the R2008C if not already done.

Enter mobile initiated sequence test screen.

The R2008C starts a continuous stream of system parameter overhead messages.

### MOBILE

Perform initialization task.

- A. Scan control channels.
- B. Tune to R2008C FOCC.
- C. Acquire word sync.
- D. Receive overhead message.
- E. Update overhead information.

Perform paging channel selection task.

- A. Scan paging channels.
- B. Tune to R2008C FOCC.
- C. Acquire word sync.
- D. Receive overhead message.
- E. Perform overhead message processing task.

Enter idle task. Examine data for:

- A. Page match.
- B. User request.
- C. Order.
- D. Overhead message.

Enter origination task:

- A. Scan access channels.
- B. Examine call state.
- C. Tune to R2008C FOCC.
- D. Acquire word sync.
- E. Read digital color code (DCC).
- F. Retrieve access protocol parameters.
- G. Wait random delay.
- H. Re-examine call state.

- I. Seize reverse control channel, (RECC)
- J. Perform service request subtask.
- K. Send service request message.

Accept service request message and display called address, mobile number and serial number.

Send initial voice channel designation message.

Tune to FVC.

- Enter initial voice channel confirmation subtask.
- A. Tune to RVC.
  - B. Adjust rf power to VMAC.
  - C. Turn on SAT transponder.
  - D. Set DSCMM to SCC.

Accept SAT.

Enter conversation task.

Send power level command.  
High power.

Adjust power level to high and send order confirmation.

Accept order confirmation.

Manual power level testing permitted.  
Select power level 0-7.

Adjust power level to that requested and send order confirmation.

Handoff testing permitted.  
handoffs to FVC #1-4 allowed.

Handoff confirmation is 50 msec signaling tone.

Change to new RVC.

Confirm 50 msec signaling tone for handoff.  
Switch to new FVC.

SAT drop testing permitted.  
SAT selections 1-3 allowed.

If a new SAT is selected, the  
mobile should drop after 5 seconds.

Repeat power level and/or handoffs  
as desired.

Temporary exits allowed to analyze  
signals using the other R2008C modes.

On-hook (mobile hangs up).  
Sends 1.8 second signaling tone  
(10 kHz)

Accept 1.8 second termination  
signaling tone. Display error if  
out of limits.

End of mobile initiated sequence test.

## APPENDIX E WARNING AND ERROR MESSAGES

The warnings and errors possible in cellular testing are outlined in the following table.

### SUMMARY OF WARNING AND ERROR MESSAGES

#### WARNINGS

001 Power level order confirmation not accepted.  
002 Time out in 45 MHz offset set  
003 Handoff signaling tone out of limits.  
004 Termination signaling tone out of limits.  
005 Invalid DTMF keycode.  
007 Incorrect SAT returned.

#### ERRORS

004 Channel out of 1-666 limit  
011 Page response not valid  
012 Page response not received  
013 Alert signalling tone not accepted  
014 Handoff signalling tone not accepted  
018 Service request message invalid  
019 SAT not returned  
020 Invalid operand for 13 command  
021 Manual test command not in 1-43 range  
022 Transceiver does not acknowledge command  
023 Transceiver has not set DCL high  
024 Transceiver has not set TCL low  
025 Transceiver has not set TCL high

#### WARNING 001

Power level order confirmation not accepted. The R2008C has sent the cellular telephone a power level command. The telephone's confirmation has not been received or it has been detected as incorrect. Possible causes are low cellular telephone sensitivity, excessive loss in the RF test connections or an attenuation setting that is too high on the R2008C.

#### WARNING 002

Time out warning in 45 MHz offset adjust. The R2008C automatically adjusts the fine tuning on the Duplex Generator. This warning indicates that the adjustment is taking too long. Verify that the Image/Dplx switch is in the High position. This warning can also occur on a cold startup of the R2008C.

#### WARNING 003

Handoff signalling tone out of limits. The R2008C has detected that the duration of the 10 kHz signaling tone sent by the cellular telephone in response to a handoff message is out of limits. The typical duration is 50 msec. This warning is displayed if the duration is outside a 40-60 msec window.

WARNING 004

Termination signalling tone out of limits. The R2008C has detected that the duration of the termination 10 kHz signalling tone is out of limits. The typical duration is 1.8 seconds. This warning is displayed if the duration is outside a 1.7 to 1.9 second window.

WARNING 007

Incorrect SAT returned. The R2008C has detected that the SAT transponded back by the cellular telephone is out of limits. The three SAT tones are 5970, 6000 and 6030 Hz. The R2008C allows a window of  $\pm 10$  Hz around the proper SAT. This warning can also be induced if a large amount of background noise is present while initiating a sequence test, while doing handoffs or while performing an auto test sequence.

ERROR 004

Channel out of 1-666 limit. A channel number entered in the initial parameters screen, is outside the 1-666 limit allowed as valid FOCC and FVC'S.

ERROR 011

Page response not valid. The page response sent by the cellular telephone is not valid. This error can be induced if the squelch control is set too close to 'breaking' or if the signal from the cellular telephone is attenuated too much due to a problem with the RF cable hookup, the R2008C has too much attenuation dialed in on its front panel or if the cellular telephone has a transmitter that is below normal power. This is visually verified by looking at the red Sig Lvl lamp on the R2008C front panel and by checking the current drawn by the transceiver unit. Normally, the LED will light once for a split second to indicate the R2008C has received a paging reply. If the LED flickers several times over a 2 second period, the cellular telephone is trying to reply but the R2008C does not recognize the transmission as a valid page response. If the LED does not light, Check to be sure the car telephone is set up and that power is applied properly.

ERROR 012

Page response not received. This error indicates that the cellular telephone is not responding to a page message issued by the R2008C. Check the R2008C Sig Lvl LED as in error 11 above. Also, if the transceiver unit is transmitting, as verified by increased current draw, the radio may be locked onto a spurious signal from the R2008C Duplex Generator. If this is suspected, a 60 dB attenuator (part no. 58-80314B21) may be inserted in series with the Duplex Generator output jack.

ERROR 014

Handoff Signalling Tone not accepted. The mobile issues a 50 msec burst of signalling tone (10 kHz) in response to a handoff order while in the conversation mode. This error indicates that the R2008C detects this tone to be outside a 40 to 60 msec window.

ERROR 18

Service request message invalid. The R2008C has received a data packet from the mobile but it is not interpreting the received data as a valid service request message. This can be caused by the squelch breaking prematurely on the R2008C, or by noise mixed with the incoming data packet. Make certain that the squelch on the R2008C is not 'breaking' on noise. In normal operation, the Sig Lvl LED on the R2008C will flash briefly while the R2008C accepts the service request message. If the R2008C has difficulties recognizing the service request, the LED will flicker several times during a 2 second interval. Verify good RF cable connections. Check the attenuation setting on the R2008C (typically set at -50 dB).

ERROR 19

SAT not returned. A supervisory audio tone (SAT), even the wrong SAT, has not been returned by the cellular telephone. This error generally indicates that the cellular telephone has not shifted frequencies correctly as a result of an initial voice channel designation message or a handoff message. This error can be induced if the background ambient noise during a test is excessive.

\*NOTE: The following errors are related to the manual test mode. Refer to Fig. 11 for an example of the STATUS command transfer sequence.

ERROR 21

Manual test command not in 1-43 range. The command entered is not in the 1-43 range of commands allowed by the AMPS spec.

ERROR 22

Transceiver does not acknowledge command. The transceiver does not acknowledge the command just sent. It can result if the cable between the R2008C and the transceiver unit is not making good connection. Also check power connection to the mobile unit. Only 5 of the 43 commands will function before an 01 SUSPEND command is sent, these are: STATUS, TURNAROUND, RESTART, RESET and SUSPEND.

ERROR 23

Transceiver has not set DCL high. This error indicates that a command requiring returned information has been sent, but the direction control line (DCL) has not been set high by the transceiver unit, a necessary condition for the returned data transfer. This line is controlled by the transceiver.



ERROR 24

Transceiver has not set TCL low. This error indicates that a command requiring returned data has been sent, and the direction control line (DCL) has gone high indicating the transceiver understands that it is to return data, however, the test control line (TCL) has not gone low. The TCL must go low to indicate valid data on the manual bus.

ERROR 25

Transceiver has not set TCL high. This error indicates that a command requiring returned information has been sent, and the DCL has gone high indicating the transceiver is to return data, and the TCL has gone low to flag the R2008C to read the data from the manual bus, however, the TCL has not gone back high to indicate the R2008C has read the manual bus. The transceiver should return TCL high when it senses that the R2008C has lowered the clock line (CL) and has returned it high after reading data from the transceiver on the manual bus.

## APPENDIX F MANUAL TEST COMMANDS

- 01 SUSPEND - Terminate the normal mode and enter the test mode. Perform initialization as specified by the INIT command and await further test commands. The autonomous timer shall be reset periodically unless a RESETOFF command received.
- 02 RESTART - Terminate the test mode, enter the normal mode and restart call processing tasks.
- 03 STATUS - Return the transceiver unit status to the R2008C. Status definitions are:  
PL: Power level 0 (highest) - 7 (lowest)  
CARR: carrier (1-on)  
TN: Signaling tone (1-on)  
TXM: Transmit audio mute (1-muted)  
RXM: Receive audio mute (1-muted)  
WS: Word synchronization (1-ws acquired)  
MODE: 1-control channel, 0-voice channel  
BI: Current state of majority voted busy/idle (0-busy, 1-idle)  
SAT: SAT frequency is encoded as follows:  
00 - 5970 Hz  
01 - 6000 Hz  
10 - 6030 Hz  
11 - NO SAT LOCK
- 04 RESET - Reset the autonomous timer
- 05 TURNAROUND - echo the byte following the command to the R2008C  
- requires 1 byte additional data
- 06 INIT - Initialize the transceiver unit to the following state:  
1 - Carrier off  
2 - Attenuation - 0 DB  
3 - Receive audio muted  
4 - Transmit audio muted  
5 - Signaling tone off  
6 - Autonomous timer reset and its periodic resetting enabled  
7 - SAT-off  
8 - DTMF and audio tones-off
- 07 CARRIER-ON - Turn the carrier on. Transpond SAT only if the SATON command was previously received.
- 08 CARRIER-OFF - Turn the carrier off.
- 09 LOAD-SYNTH - Set the synthesizer to the channel specified by the 3 digits following the command: e.g. 334 sets synthesizer to channel #334.

- 10 SET-ATTN - Set the RF power attenuation to the value specified in the data byte following the command.  
0-7 for lowest to high - attenuation
- 11 RXMUTE - Mute the receive-audio signal.
- 12 RXUNMUTE - Unmute the receive-audio signal.
- 13 TXMUTE - Mute the transmit-audio signal.
- 14 TXUNMUTE - Unmute the transmit-audio signal.
- 15 RESETOFF - Discontinue periodic resetting of the autonomous timer (allow timer to time out).
- 16 STON - Transmit a continuous signaling tone.
- 17 STOFF - Stop transmission of the signaling tone.
- 18 SETUP - Transmit a 5-word reverse control channel message. the digital color code shall be 11 and - each of the 5 words shall consist of the following 48-bit data pattern (repeated 5 times): FF,00,AA,55,CC,33. No channel scan, busy-idle determination, or BCH encoding is to be performed. (There may or may not be forward control channel data present). The transceiver unit shall turn on the carrier at the start of transmission and turn off the carrier at the termination.
- 19 VOICE - Transmit a 2-word reverse voice channel message. Each of the 2 words shall consist of the same 48-bit data pattern specified for the setup command. The Transceiver unit shall turn on the carrier at the start of transmission and turn off the carrier at the termination.
- 20 RCVSU - Receive a 2-word forward control channel message, perform majority voting but no error correction and return the 10 bytes of data received to the TS.
- 21 RCVVC - Receive a 1-word forward voice channel message perform majority voting but no error correction, and return the 5 bytes of data received to the TS.
- 22 SEND-NAM - Return the information contained in the number assignment module (NAM) to the TS.  
- Number assignment module. The number assignment module (NAM) is a separate entity in the mobile equipment that shall store the following information.

- System identification of home mobile service area (SID). The SID is a decimal number corresponding to a 15 bit binary number assigned to a particular system used by the mobile equipment to make the home/roam decision.
- Local use mark. This 1-bit mark is used to make the local control state decision.
- Min mark. This 1-bit mark when set to '1' indicates that home mobile equipment shall send extended address information upon origination and page response.
- Mobile identification number (MIN). The MIN (consisting of MIN1 and MIN2) is a 34-bit number that identifies the mobile equipment.
- Station class mark (SCM). The SCM is a 4-bit number that identifies the type of the mobile equipment.
- Initial paging channels in home MSA (IPCH). The IPCH is an 11-bit number that is the channel number of the first control channel on which the mobile equipment will receive pages when it is in its home MSA.
- Access overload class (ACCOLC). The ACCOLC is a 4-bit number that identifies which overload class field is used to control access by the mobile equipment.
- Preferred system mark. This 1-bit mark when set to '1' identifies that the mobile equipment's preferred system is system A (RCC), otherwise, the preferred system is system B (WCC).
- Group identification mark (GIM). The GIM is a 4-bit number indicating how many bits of the SIDH, starting with the most significant, comprise the group identification.
- Lock combination. This 12-bit number represents the sequence of three decimal digits that is used in unlocking the mobile equipment.
- End-to-end signaling mark. This 1-bit mark when set to '1' indicates that the mobile equipment will have a DTMF keypad while in conversation mode.
- Repertory mark. This 1-bit mark when set to '1' indicates that the mobile equipment is optioned for repertory (number memory) storage.
- Horn-alert mark. This 1-bit mark when set to '1' indicates that the mobile equipment is optioned for horn-alert.

- Hands-free mark. This 1-bit mark when set to '1' indicates that the mobile equipment is optioned for use with a hands-free control unit.
- 23 VERSION - Return the software version information to the R2008C.
- 24 SEND-SN - Return the 32-bit serial number to the R2008C. Display in hexadecimal.
- 25 MEM - Return the resident memory data located at the address specified in the 2 bytes following the command. The first and second bytes shall contain, respectively, the most and least significant parts of the 16-bit address.
- 26 RCVS1 - Receive contiguous 1-word messages on the control channel. Perform majority voting and error correction on each message. Maintain separate counts of the number of uncorrectable and correctable errors detected until a terminate command is received. If the count exceeds 255 (decimal), a count of 255 is to be returned.
- 27 RCVV1 - Same as RCVS1 except on the voice channel.
- 28 WSTS - Receive contiguous 1-word messages on the control channel. Maintain a count of the number of word synchronization sequences (11100010010) detected until a terminate command is received. The counter shall be 16 bits wide and the data shall be returned in the following format:
 

BYTE 1	15	-	-	-	-	-	-	8
BYTE 2	7	-	-	-	-	-	-	0
- 29 WSTV - Same as WSTS except on the voice channel.
- 30 BIBIT - Receive continuous forward control channel data, extract and perform majority voting on the busy-idle bits, and respond to STATUS commands, and return the current state of the majority voted busy-idle bit. Reception of an INIT command terminates sequence.
- 31 TERMINATE - Terminate operation off the previously issued RCVS1, RCVV1, WSTS, or WSTV command and return the data collected to the TS.
- 32 SATON - Enable the transmission of SAT. The byte of data following the operational code shall contain the code of the SAT frequency that the transceiver unit may expect to receive (see table below). SAT shall be transponded if the carrier is currently on or if a subsequent CARRIER-ON command is received.

<u>SAT CODE</u>	<u>SAT FREQUENCY</u>
00	5970 Hz
01	6000 Hz
02	6030 Hz

- 33 SATOFF - Disable the transmission of SAT.
- 34 CDATA - Transmit continuous 5-word reverse control channel messages. The digital color code shall be 10. each of the 5 words shall consist of the 48-bit data pattern specified by the 6 bytes of data following the command. The data messages shall be contiguous. Subsequent reception of an init command shall terminate the transmission. The transceiver unit shall turn on the carrier at the start of transmission.
- 15 HITNON - Activate the high audio tone (1150 Hz) and apply it to the receive-audio line.
- 36 HITNOFF - Deactivate the high audio tone.
- 37 LOTNON - Activate the low audio tone (770 Hz) and apply it to the receive-audio line.
- 38 LOTNOFF - Deactivate the low audio tone.
- 39 INVM - Initialize non-volatile memory. Set registration memory and called-address repertory memory to zeros. Set lock state to active (locked).
- 40 RNVM - Read non-volatile memory and return to TS. The least-significant bit of the first byte transmitted shall contain the lock state, 1-active (locked). The next 80 bytes transmitted shall contain the called-address repertory (10 called-addresses (0-9), 8 bytes each). The first byte transmitted shall contain the two most-significant digits of called-address 9. The next 20 bytes shall contain the registration memory (4 entries of 5 bytes each). Each group of 5 bytes shall be transmitted with the most-significant byte first.
- 41 WNVN - Receive 101 bytes from the TS (formatted as in RNVM) and write them to the non-volatile memory.

42 DTMFON - Activate the DTMF generator with the tones associated with the keycode given in the byte following the command. Apply DTMF signals to the modulator and DTMF sidetone to the receive-audio line.

KEY CODES			
00-09	CORRESPOND TO 0-9 ON KEYPAD		
10	*	15	AUX ALERT
11	#	16	CLR
12	SEND	17	STORE
13	END	18	RECALL
14	LOCK	19	MUTE

43 DTMFOFF - deactivate the DTMF generator.

## EPSON RX-80 PRINTER SETUP

The optional RT-RX80/8148 printer as shipped by EPSON is configured for parallel operation. To use it with the R2008C, the 8148 serial interface card must be installed. Both the main PC board in the printer and the interface card have a series of DIP switches that must be set as follows:

		Main Board	
DIP SW1	1-1 off	DIP SW2	2-1 on
	1-2 off		2-2 on
	1-3 off		2-3 off
	1-4 off		2-4 off
	1-5 off		
	1-6 on		
	1-7 on		
	1-8 on		
		8148 Serial Board	
DIP SW1	1-1 off	DIP SW2	2-1 on (off=parallel)
	1-2 off		2-2 on
	1-3 off		2-3 off
	1-4 off		2-4 off
	1-5 on		2-5 off
	1-6 off		2-6 off
	1-7 off		
	1-8 off		

Leave jumpers in factory set position.

Note: If the printer is also to be used as a parallel printer for the R-1801A NAM application, DIP SW2-1 on the 8148 board may be brought out to an external toggle switch. In this case, leave SW2-1 off.

These switch settings correspond to:  
1200 baud, no parity, 8 bit word length



MOTOROLA, INC.  
 COMMUNICATIONS SECTOR  
 TEST EQUIPMENT SERVICE CENTER  
 1313 EAST ALGONQUIN ROAD SCHAUMBURG, ILLINOIS 60196

TEST EQUIPMENT SERVICE CENTER  
 2333 B. Utah Avenue, El Segundo, CA

**TEST EQUIPMENT SERVICE REQUEST FORM**

This completed form must accompany equipment returned for service.

CUSTOMER'S PURCHASE ORDER NO.		DATE	
MODEL NUMBER		SERIAL NUMBER	
DESCRIPTION OF PROBLEM:			
REQUESTED SERVICE:			
SHIP TO ADDRESS:			
SHIP VIA:			

Providing the information below will reduce the turnaround time on your Test Equipment Service.

MOTOROLA CUSTOMER NUMBER	BILL TAG	SHIP TAG	INTERNAL MOTOROLA ACCOUNT NO.

SIGNED: \_\_\_\_\_







82011

COMMUNICATIONS SYSTEM ANALYZER

68P81069A70-O

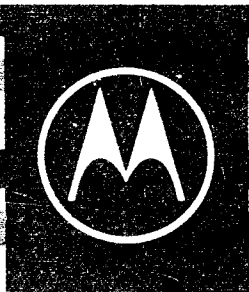

88761